

Centre Number						Candidate Number				
Surname										
Other Names										
Candidate Signature										

For Examiner's Use	
Examiner's Initials	
Pages	Mark
3	
4 – 5	
6 – 7	
8 – 9	
10 – 11	
12 – 13	
14 – 15	
16 – 17	
18 – 19	
20 – 21	
22 – 23	
24	
TOTAL	



General Certificate of Secondary Education
Foundation Tier
November 2013

Mathematics

43603F

Unit 3

Monday 11 November 2013 9.00 am to 10.30 am

F

<p>For this paper you must have:</p> <ul style="list-style-type: none"> • a calculator • mathematical instruments. 	
---	--

Time allowed

- 1 hour 30 minutes

Instructions

- Use black ink or black ball-point pen. Draw diagrams in pencil.
- Fill in the boxes at the top of this page.
- Answer **all** questions.
- You must answer the questions in the spaces provided. Do not write outside the box around each page or on blank pages.
- Do all rough work in this book.
- If your calculator does not have a π button, take the value of π to be 3.14 unless another value is given in the question.

Information

- The marks for questions are shown in brackets.
- The maximum mark for this paper is 80.
- The quality of your written communication is specifically assessed in Questions 10 and 15. These questions are indicated with an asterisk (*).
- You may ask for more answer paper, graph paper and tracing paper. These must be tagged securely to this answer booklet.

Advice

- In all calculations, show clearly how you work out your answer.



N 0 V 1 3 4 3 6 0 3 F 0 1

WMP/Nov13/43603F/E4

43603F

Formulae Sheet: Foundation Tier

Area of trapezium = $\frac{1}{2}(a+b)h$

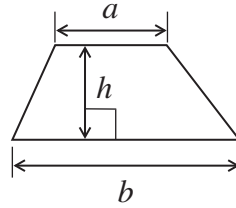

Volume of prism = area of cross-section \times length

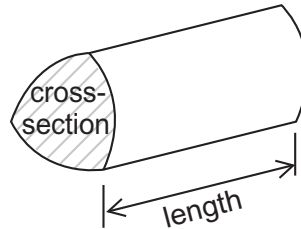

Answer **all** questions in the spaces provided.

1 Here are four rods.

Not drawn accurately

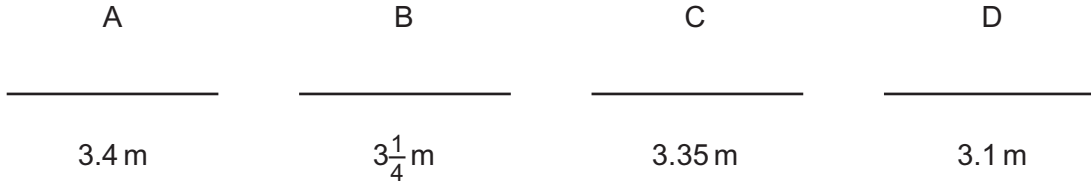

1 (a) Which rod is the longest?

Answer (1 mark)

1 (b) Work out the total length of rod C and rod D.

.....

Answer m (1 mark)

1 (c) Which **three** rods have a total length of 10 metres?

.....
.....
.....

Answer and and (2 marks)

4

Turn over ►



2 Here are six words that are used with circles.

arc chord diameter sector segment tangent

Put the correct word from the list in each box.

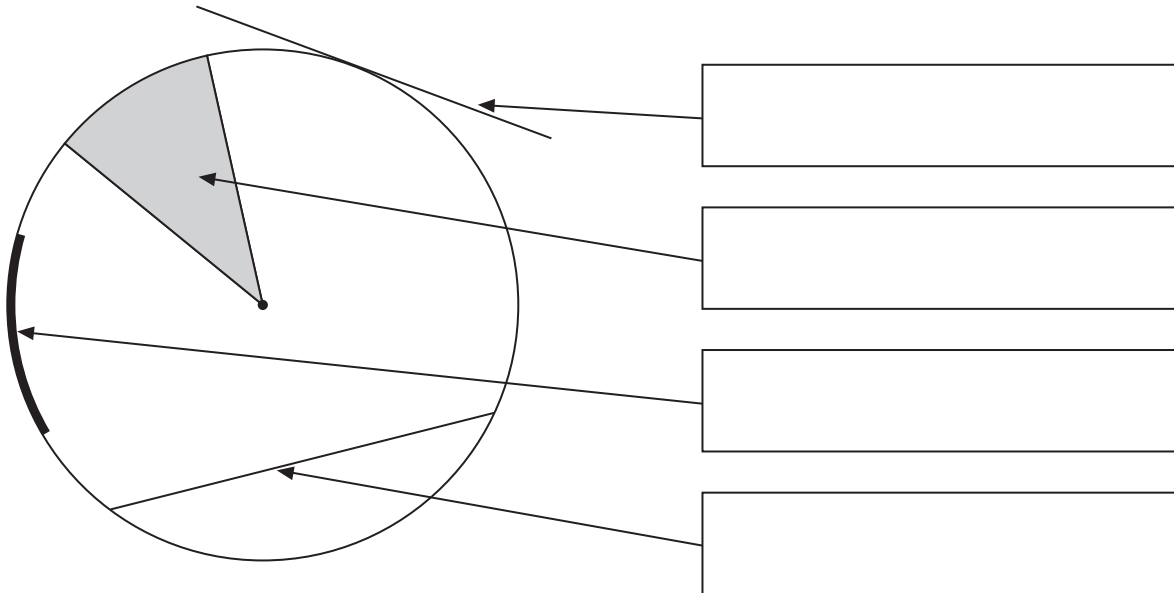

(4 marks)



3 A straight road connects Bristol and London.

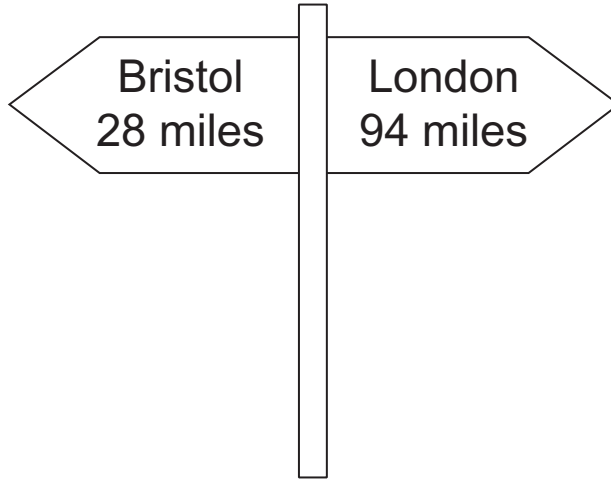
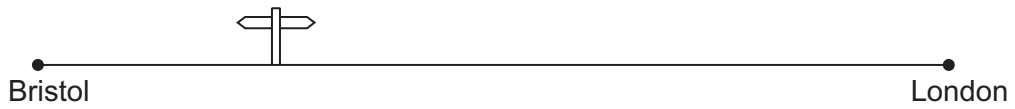

3 (a) Use the sign to work out the distance from Bristol to London.

.....

Answer miles (2 marks)

3 (b) How much further is it to London than to Bristol from the sign?
Give your answer to the nearest 10 miles.

.....
.....

Answer miles (3 marks)



4 (a) Measure the size of the **acute** angle.

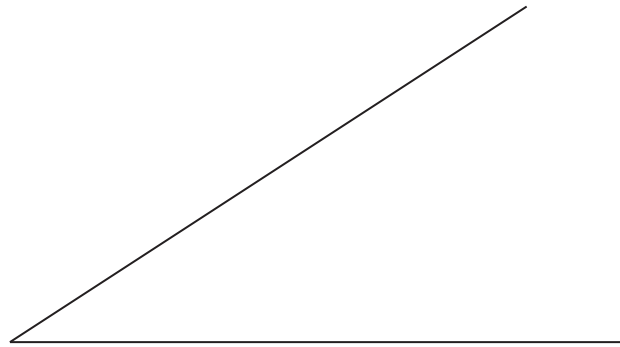

Answer degrees (1 mark)

4 (b) Measure the size of the **obtuse** angle.

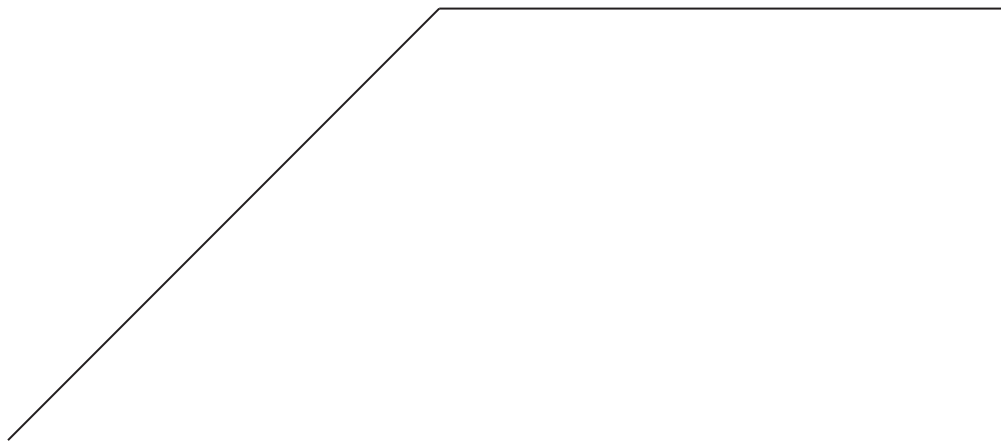

Answer degrees (1 mark)



5 A banana is weighed.

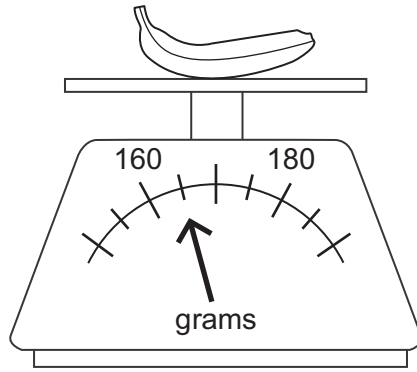

5 (a) How much does the banana weigh?

Answer grams (1 mark)

5 (b) The banana is now weighed with an orange.

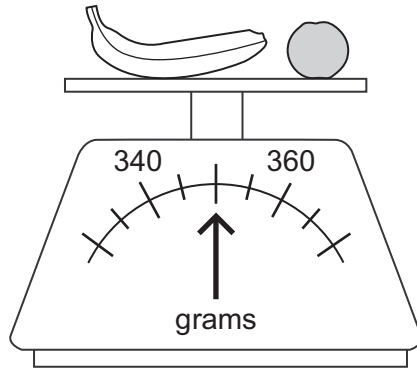

How much does the orange weigh?

.....

.....

Answer grams (2 marks)



6 (a) Draw **all** the lines of symmetry on this rectangle.



(2 marks)

6 (b) Draw a shape that has exactly

four sides

and

one line of symmetry.

(1 mark)



7 (a) This cuboid is made from centimetre cubes.

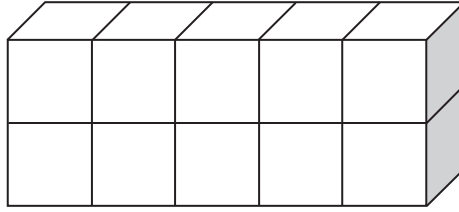

Write down the volume of the cuboid.
State the units of your answer.

Answer (2 marks)

7 (b) Here is a cuboid measuring 5 cm by 2 cm by 2 cm.

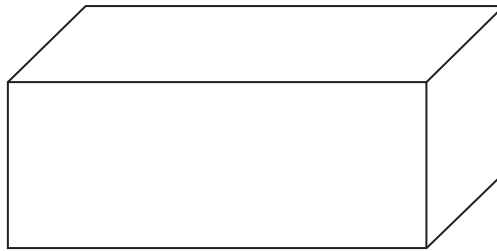

How many centimetre cubes are needed to make this cuboid?

.....

Answer (2 marks)



8 (a) The diagram shows a square.

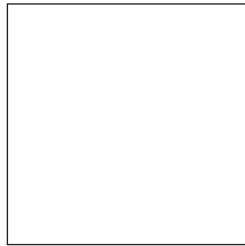

$(x - 3)$ cm

Not drawn
accurately

How do you know that x is greater than 3?

.....
.....

(1 mark)

8 (b) Here is a different square.

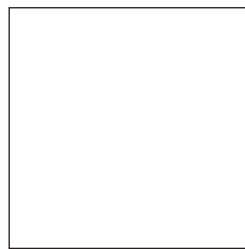

$(y + 4)$ cm

Not drawn
accurately

The area is 81 cm^2 .

Work out the value of y .

.....
.....

$y =$

(2 marks)



9 Here is a centimetre grid with point P plotted.

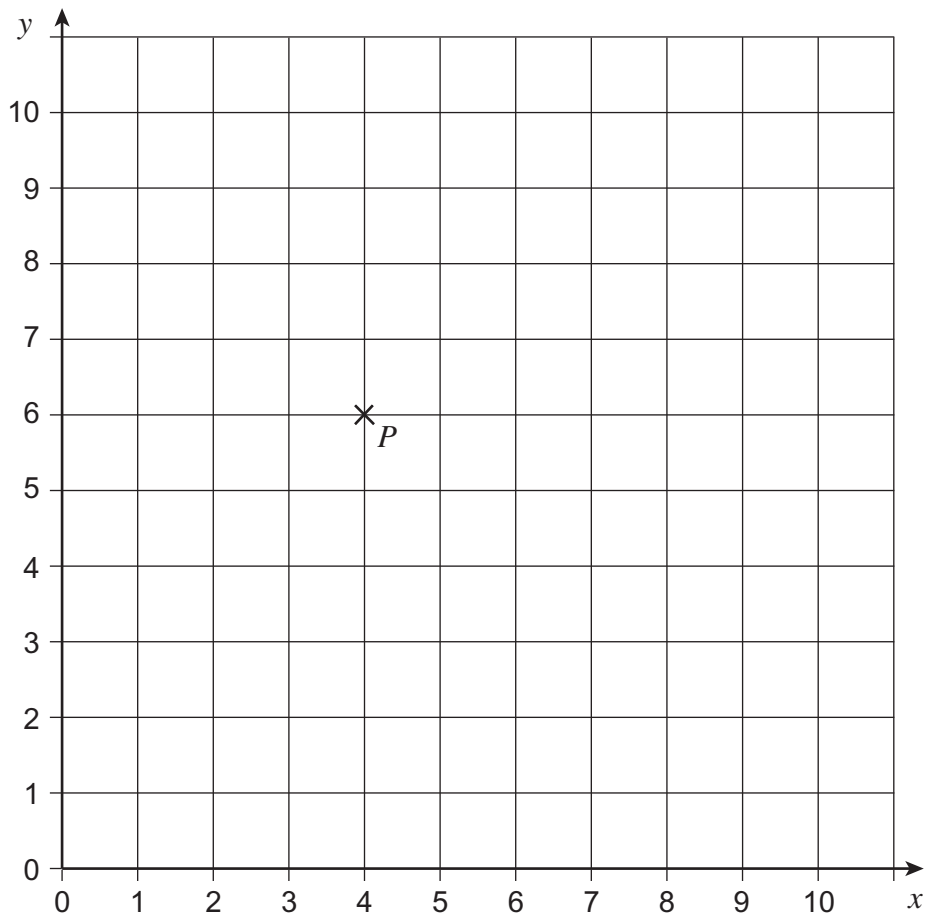

A circle has centre P and radius 4 cm.
The circle passes through the points A , B , C and D .

Complete the coordinates for A , B , C and D .

A (..... , 2)

B (8 ,)

C (..... , 10)

D (0 ,)

(4 marks)



10 *ABC* is a straight line.

Not drawn
accurately

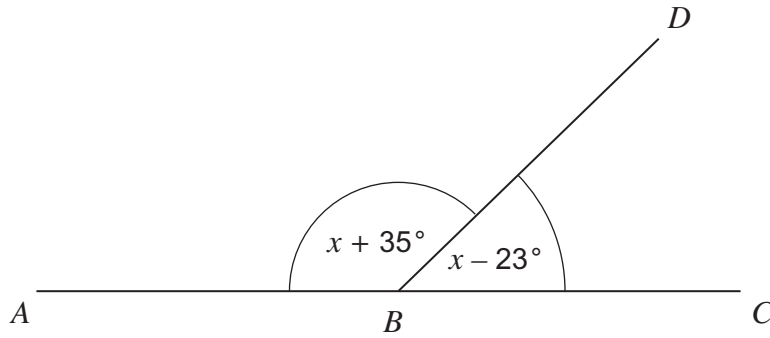

10 (a) How much bigger is angle *ABD* than angle *CBD*?

.....
.....

Answer degrees (2 marks)

*10 (b) Set up and solve an equation to work out the size of angle *ABD*.

.....
.....
.....
.....
.....
.....

Answer degrees (4 marks)



11 (a) How many litres are equivalent to 1 gallon?

Circle your answer.

2.2

2.5

4.5

5

8

(1 mark)

11 (b) 1 mile = 1760 yards

Convert 12 056 yards to miles.

Give your answer to the nearest mile.

.....
.....

Answer miles (3 marks)

12 The scale on a map is 1 : 500 000

Two towns are 8 cm apart on the map.

Work out the actual distance between the towns.

Give your answer in kilometres.

.....
.....
.....
.....

Answer km (3 marks)



13 (a) In the diagram, $AB = AC$

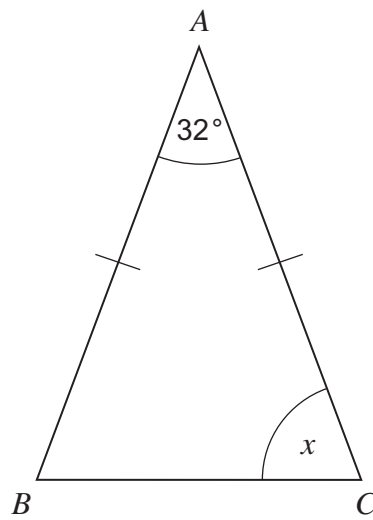

Not drawn
accurately

Work out the size of angle x .

.....
.....

Answer degrees (2 marks)



13 (b) A rhombus is reflected as shown.
DE is a straight line.

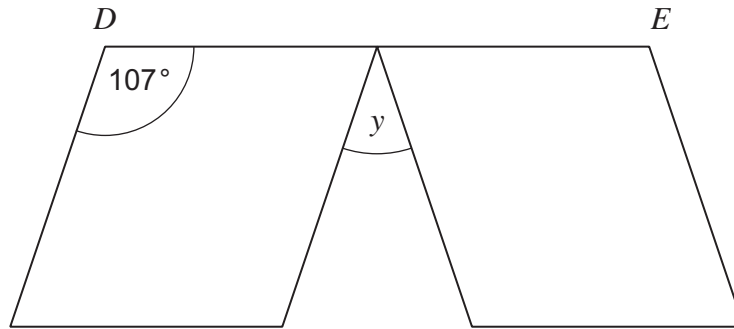

Not drawn
accurately

Work out the size of angle *y*.
Show your working, which may be on the diagram.

.....

.....

.....

.....

.....

.....

Answer degrees (3 marks)

Turn over for the next question



14 Make an accurate drawing of this cuboid on the isometric grid.
One edge has been drawn for you.

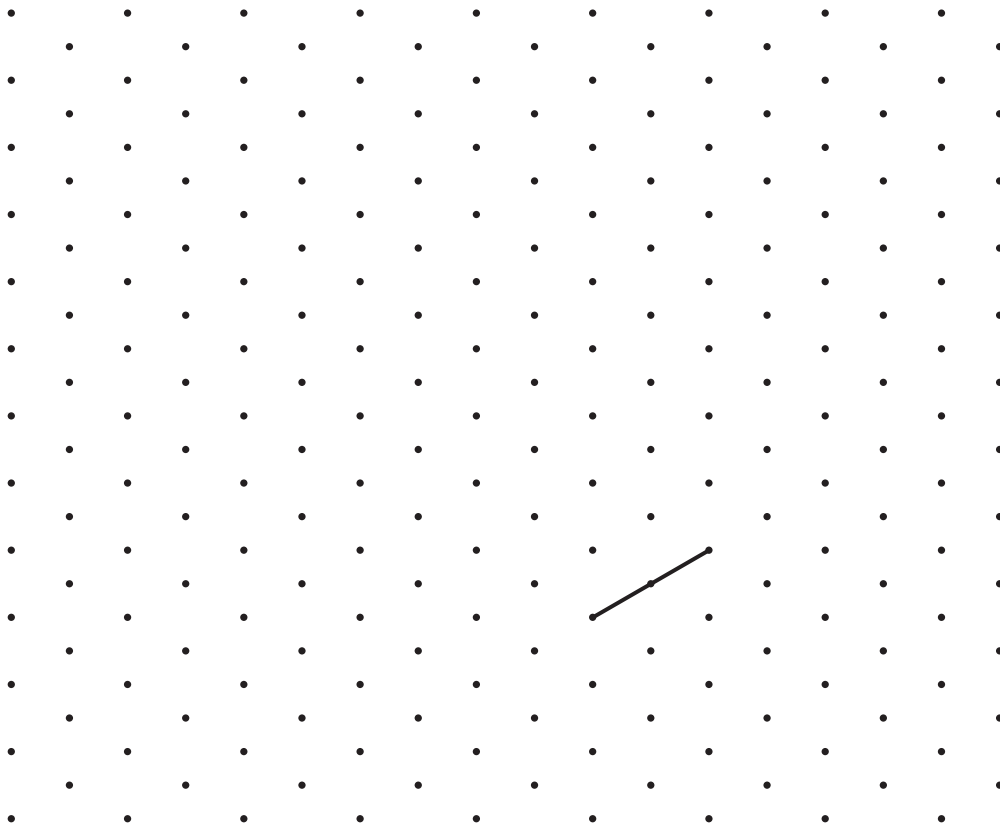
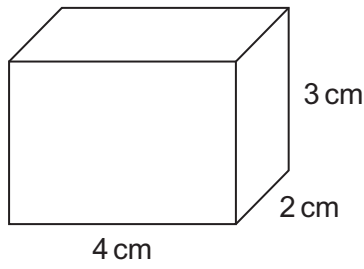

(2 marks)



***15**

Lengths of wood for door frames are 2100 mm each.
The lengths are sold in packs of 5.

Each door frame needs three pieces, as shown below.

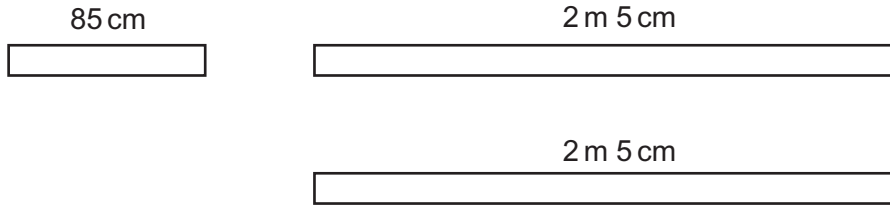

Not drawn
accurately

Jon wants to cut pieces of wood to make seven door frames.

How many packs does he need to buy?
You **must** show how you worked out your answer.

.....

.....

.....

.....

.....

.....

.....

.....

.....

Answer (4 marks)

6

Turn over ►



- 16 (a)** On the grid, draw a 90° clockwise rotation of shape *A*.
Label it *B*.

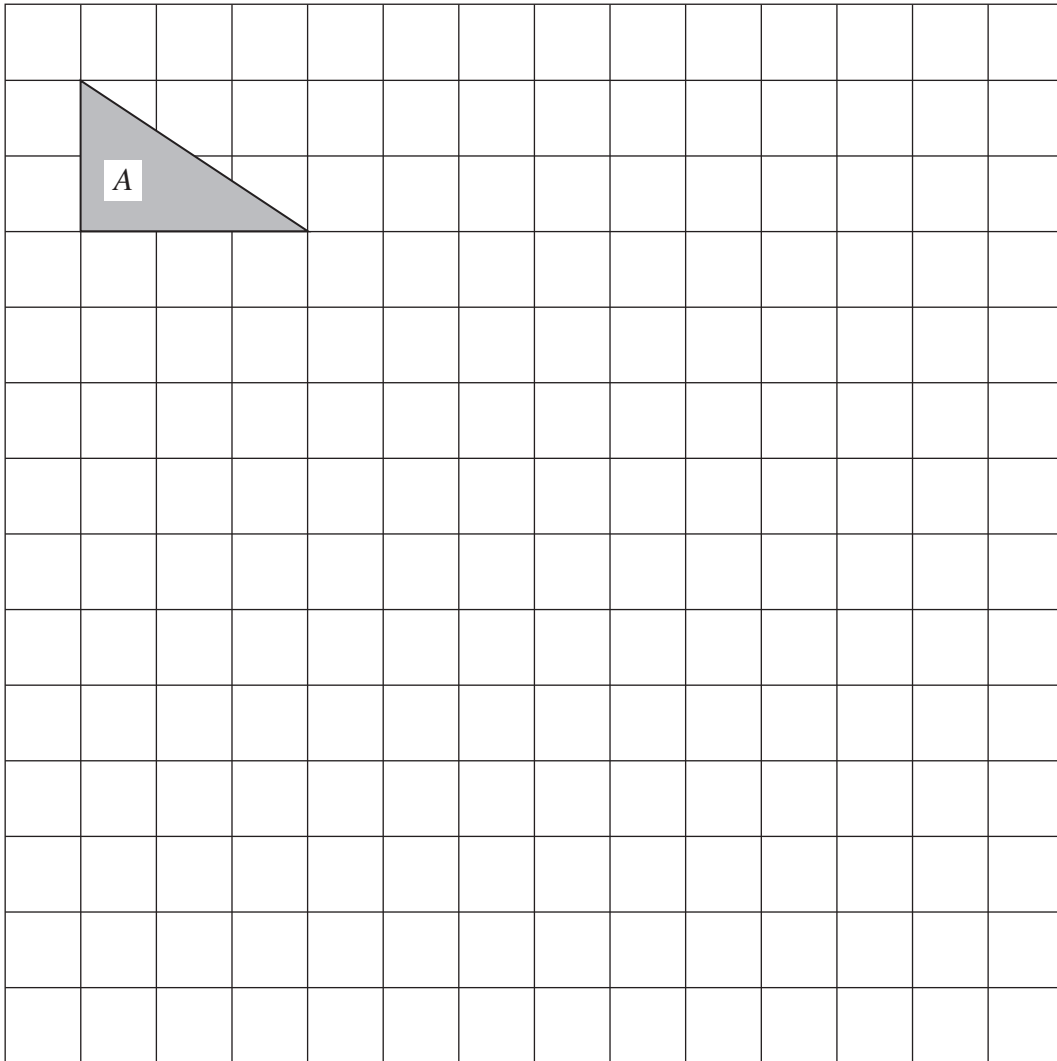

(2 marks)



16 (b) On this grid, draw an enlargement of shape *A* by scale factor 3.
Label it *C*.

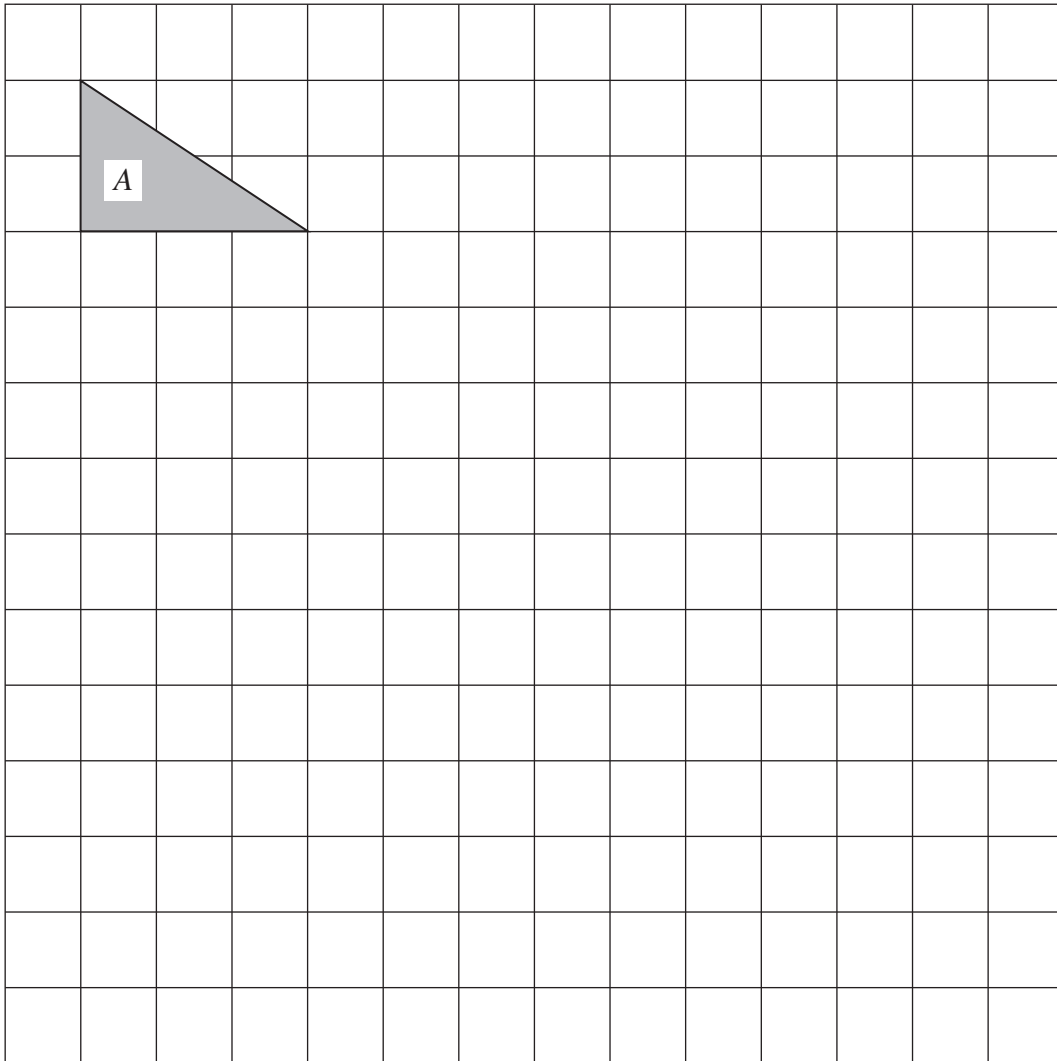

(2 marks)

16 (c) Work out the area of shape *C*.

.....
.....

Answer cm² (2 marks)



17 (a) Complete the table of values for $y = x^2$

x	-2	-1	0	1	2
y	4			1	

(2 marks)

17 (b) On the grid, draw the graph of $y = x^2$ for values of x from -2 to 2.

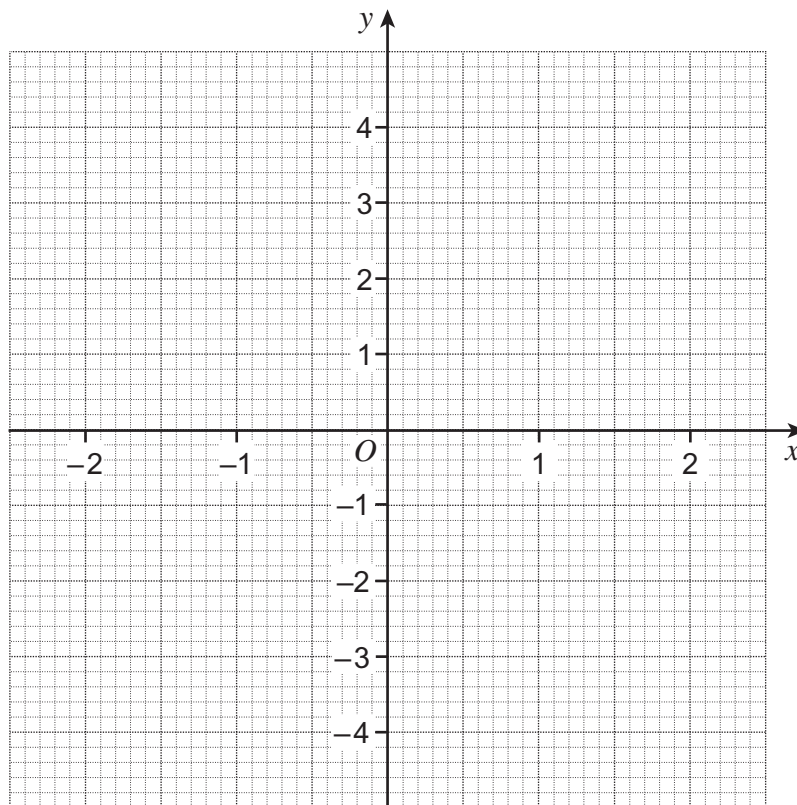

(2 marks)



18 This shape is made from identical quarter circles.

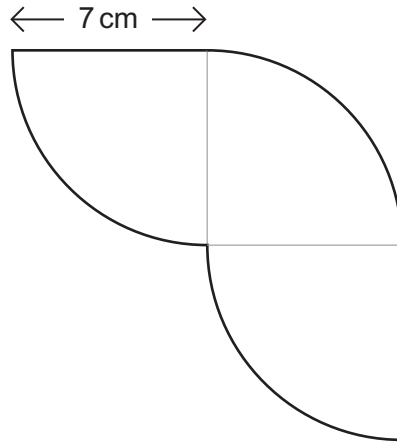

Not drawn
accurately

Work out the perimeter of the shape.

.....

.....

.....

.....

.....

.....

Answer cm (4 marks)

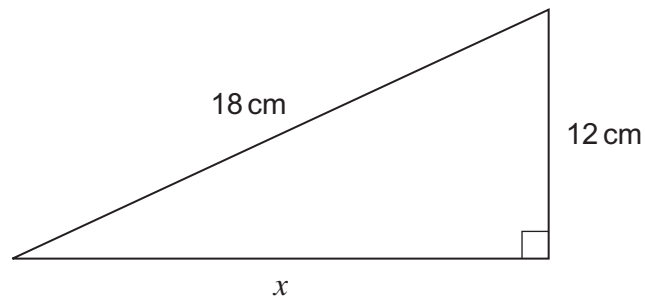

19

Work out the length x .Not drawn
accurately

Give your answer to 1 decimal place.

.....

.....

.....

.....

Answer cm (4 marks)



20

Use a calculator to work out the area of the rectangle.

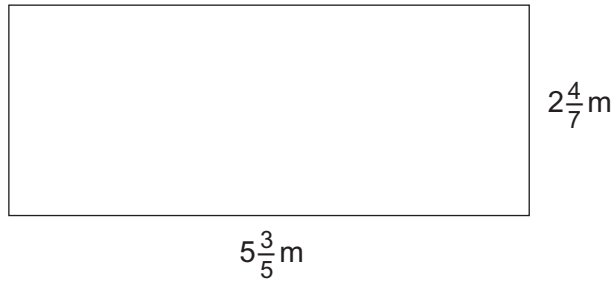
Not drawn
accurately

Give your answer as a mixed fraction.

.....

.....

.....

Answer m^2 (2 marks)**Turn over for the next question**

21 The diagram shows two cylinders.

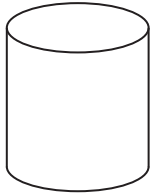

radius 4 cm
height 9 cm

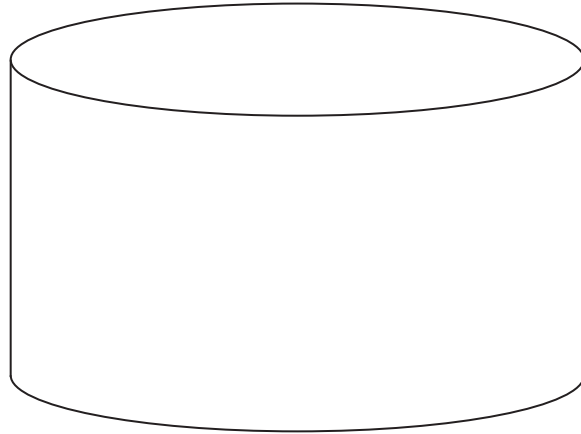

radius 10 cm
height 36 cm

How many times bigger is the volume of the large cylinder than the small cylinder?
You **must** show your working.

.....

.....

.....

.....

.....

.....

Answer (4 marks)

END OF QUESTIONS

