

Please write clearly in block capitals.

Centre number

--	--	--	--	--

Candidate number

--	--	--	--

Surname

Forename(s)

Candidate signature

GCSE MATHEMATICS (LINEAR)

F

Foundation Tier Paper 1

Wednesday 2 November 2016 Morning Time allowed: 1 hour 15 minutes

Materials

For this paper you must have:

- mathematical instruments.

You must **not** use a calculator.



Instructions

- Use black ink or black ball-point pen. Draw diagrams in pencil.
- Answer **all** questions.
- You must answer the questions in the spaces provided. Do not write outside the box around each page or on blank pages.
- Do all rough work in this book.

Information

- The marks for questions are shown in brackets.
- The maximum mark for this paper is 70.
- The quality of your written communication is specifically assessed in Questions 7, 14 and 16. These questions are indicated with an asterisk (*).
- You may ask for more answer paper, tracing paper and graph paper. These must be tagged securely to this answer book.

Advice

- In all calculations, show clearly how you work out your answer.



Formulae Sheet: Foundation Tier

Area of trapezium = $\frac{1}{2}(a+b)h$

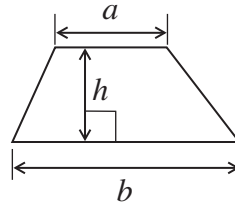

Volume of prism = area of cross section \times length

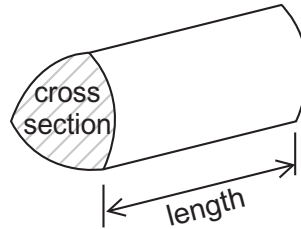

Answer **all** questions in the spaces provided.

1 (a) Circle the number that is a multiple of 9

[1 mark]

3

49

72

109

1 (b) Circle the number that is a factor of 180

[1 mark]

36

40

120

360

1 (c) Circle the number that is 3 **less** than a square number.

[1 mark]

9

28

46

98

1 (d) Circle the fraction that is equal in value to 0.4

[1 mark]

$\frac{1}{40}$

$\frac{1}{4}$

$\frac{2}{5}$

$\frac{1}{2}$



2 Work out

2 (a) $625 - 189$

[1 mark]

Answer _____

2 (b) 7×24

[1 mark]

Answer _____

2 (c) $336 \div 8$

[1 mark]

Answer _____



3 Draw a suitable diagram to show this data.

Type of tree	Frequency
Ash	8
Beech	6
Oak	7
Pine	2

[3 marks]

6

Turn over ►



4 Fitness classes cost £6 per person.

4 (a) 16 people go to the class on Monday.

Work out the total paid on Monday.

[1 mark]

Answer £ _____

4 (b) On Tuesday the total paid is £126

How many people go to the class on Tuesday?

[1 mark]

Answer _____

4 (c) The teacher says,

“The total paid on Wednesday was £37.”

How can you tell that she has made a mistake?

[1 mark]



- 4 (d)** The table shows the number of people who go to the classes on Thursday, Friday and Saturday.

Class	Number of people
Thursday	13
Friday	11
Saturday	16

The teacher earns 90% of the total paid.

How much does the teacher earn altogether on these three days?

[4 marks]

Answer £ _____

Turn over for the next question



5 In a game, players take turns to put counters on a board.
The winner is the first to get a line of 4 counters.

Example

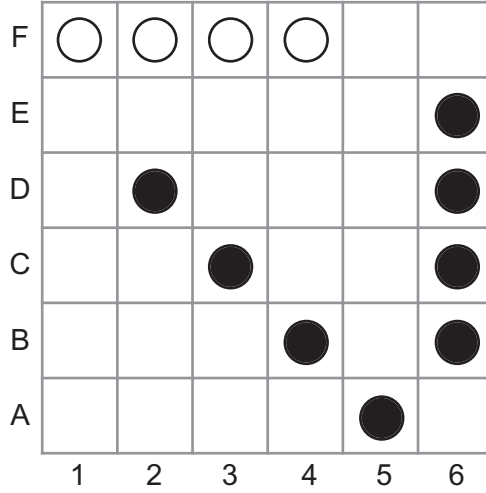

5 (a) In this game

Black has counters on (3, C) and (3, D)
White has counters on (2, C), (4, B) and (4, C)

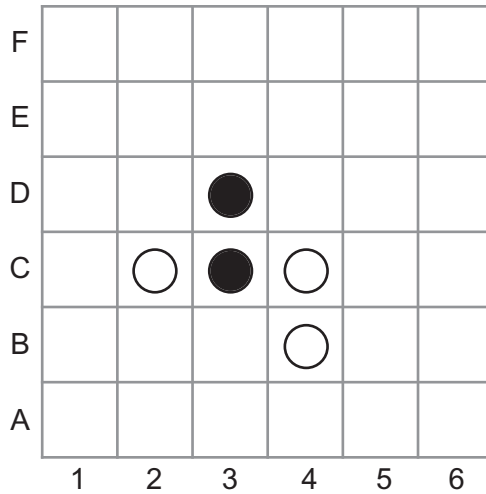

It is Black's turn to play.
He can put a counter on one of **two** squares so that he can win on his fourth go.

Which squares are they?

[2 marks]

Answer (_____ , _____) or (_____ , _____)



In this game, it is White's turn to play.

F			○	●	●	○
E	●	○	●		●	
D			●	○		○
C	○	●	○	○	○	●
B	○		●	●	○	●
A	●	○		○	●	
	1	2	3	4	5	6

5 (b) Give a reason why White **cannot** win.

[1 mark]

5 (c) Where should White play so Black **cannot** win?

[1 mark]

Answer (_____ , _____)

Turn over for the next question



- 6 (a)** Shade 6 **more** squares so that the grid has
rotational symmetry
and
no line symmetry

[2 marks]

Practise on this grid.

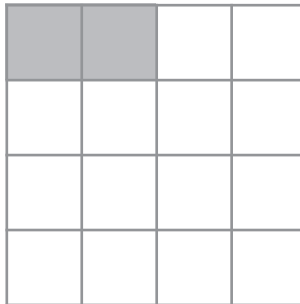

Answer on this grid.

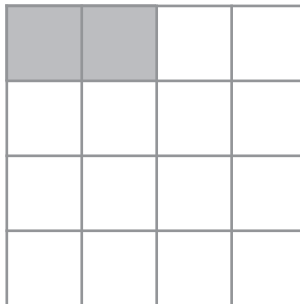

6 (b) Here is a pattern of squares.

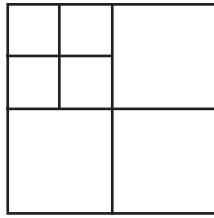

Some of the squares are shaded.

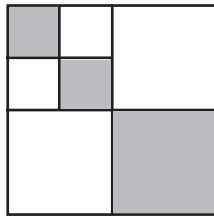

Work out the fraction of the whole pattern that is shaded.

[2 marks]

Answer _____

Turn over for the next question



7 Monty buys 4 bottles of juice.
The bottles cost £1.90 each.

He pays with a £10 note.

*7 (a) How much change does he get?

[2 marks]

Answer £ _____

7 (b) Monty gets the **smallest** number of coins possible in his change.

What coins does he get?

[1 mark]

Answer _____



8 (a) Circle the value of 3^4 [1 mark]

12

27

34

81

8 (b) Which of these numbers rounded to 1 decimal place does **not** give an answer of 3.8?
Circle your answer. [1 mark]

3.75

3.799

3.7499

3.8499

9 In a car park there are 30 cars.
One-third of the cars are red.
20% of the cars are silver.
The rest of the cars are black.

One of the cars is picked at random.

Work out the probability that it is a black car.

[4 marks]

Answer _____



- 10 The table shows the eye colour of 30 students.

Eye colour	Frequency
Brown	15
Blue	10
Green	5
Total	30

Draw a fully labelled chart to show the data.

[3 marks]

Pie chart to show eye colour of 30 students

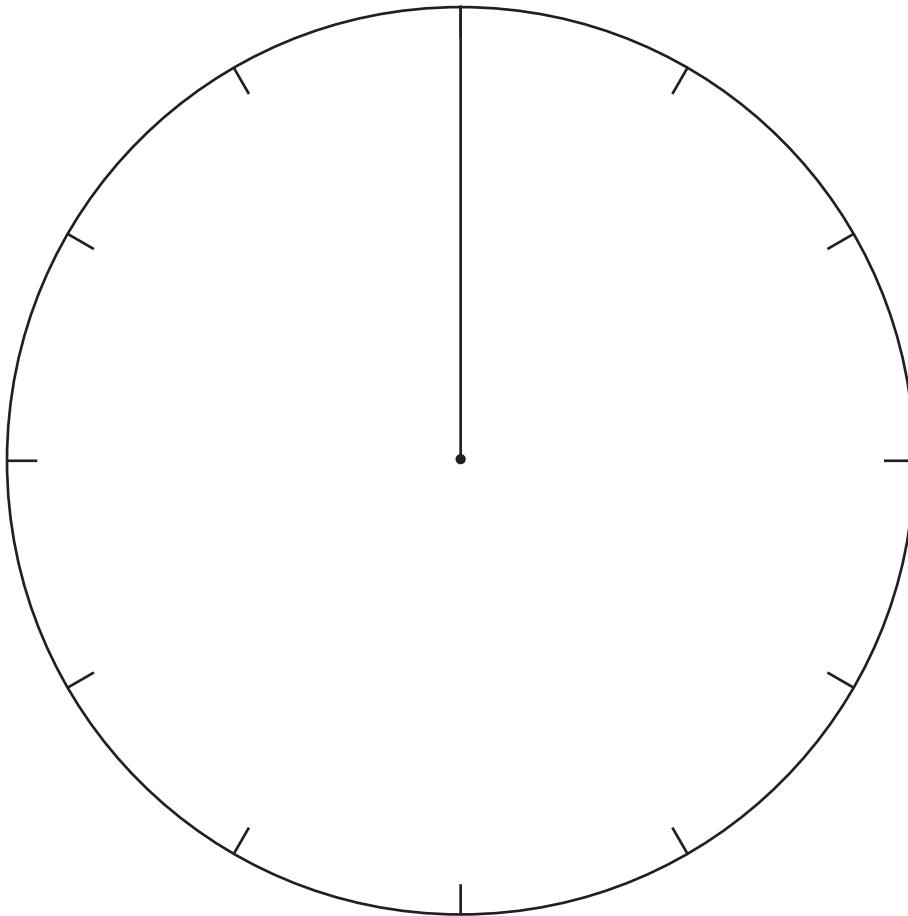

11 (a) Solve $\frac{x}{3} = 7$

[1 mark]

$x =$ _____

11 (b) Solve $y - 11 = 12$

[1 mark]

$y =$ _____

11 (c) Solve $5w - 3 = 3w + 15$

[3 marks]

$w =$ _____

Turn over for the next question



12 Six whole number cards are put in order.

All the numbers are different.

The smallest number is 2

The median is 5

The six numbers add up to 30

Complete the numbers on the cards.

[3 marks]

Answer

2					
---	--	--	--	--	--



13

A spinner has four sections A, B, C and D.
The table shows the probabilities of the spinner landing on A, B or C.

Outcome	A	B	C	D
Probability	0.2	0.3	0.15	

Work out the probability of landing on D.

[2 marks]

Answer _____

Turn over for the next question



*14 Here is a drink container and a lunch box.

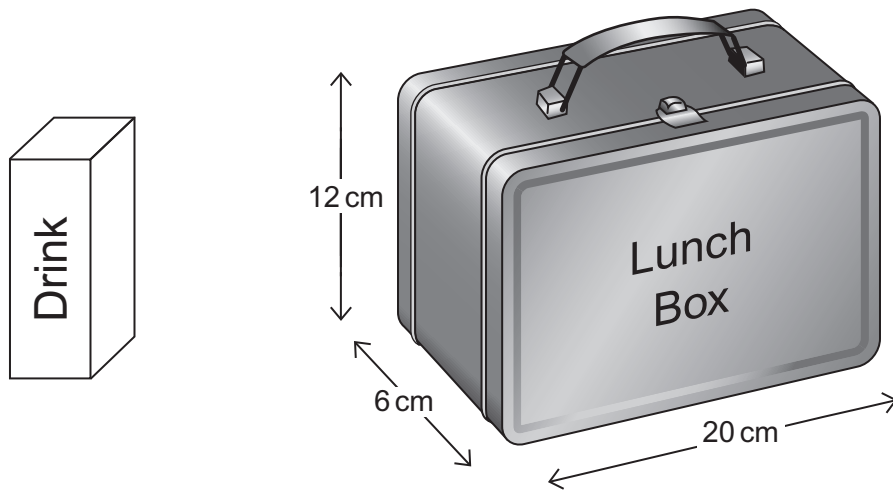

The drink container is a cuboid with a square base.
The area of the base = 25 cm^2
The volume of the container = 400 cm^3

Will the container fit inside the lunch box?
You **must** show your working.

[4 marks]



15 Here is a scale drawing of a park.

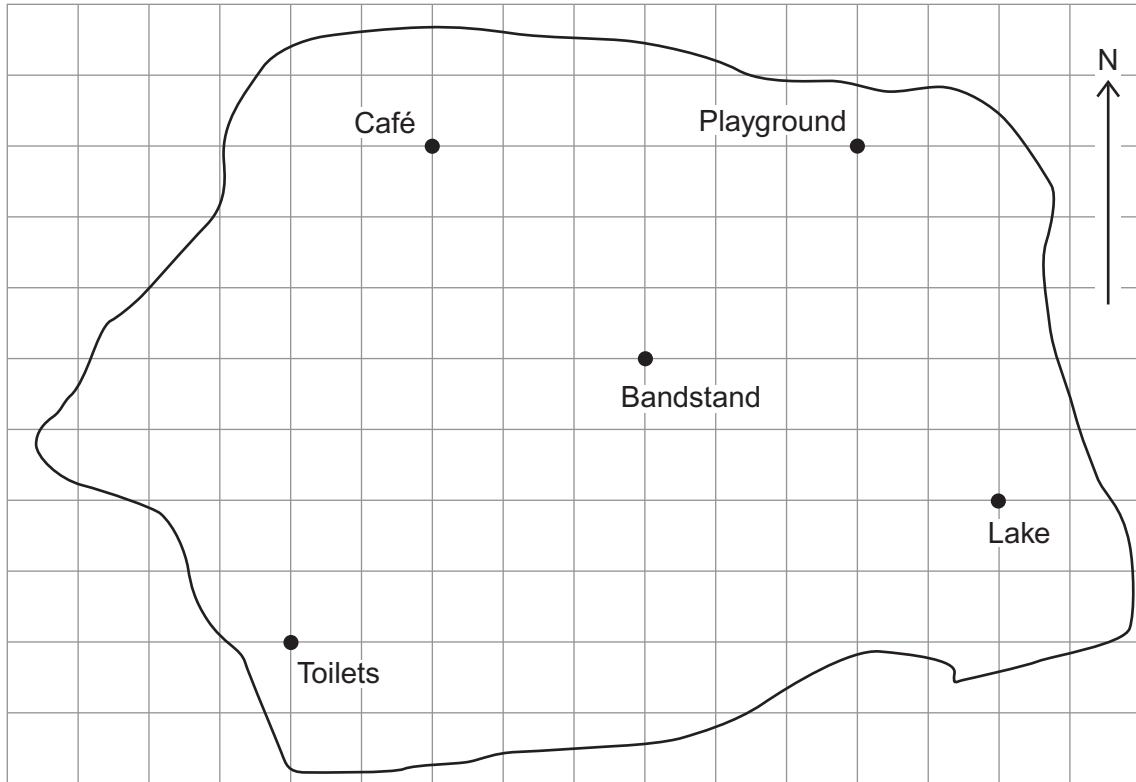

15 (a) What is North-West of the Bandstand?
Circle your answer.

[1 mark]

- Lake Toilets Café Playground

15 (b) Measure and write down the 3-figure bearing of the Playground from the Lake.

[2 marks]

Answer _____ °

15 (c) A Tower is
North of the Toilets
and
on a bearing of 220° from the Café.

Mark the position of the Tower on the scale drawing.

[2 marks]

9

Turn over ►



*16

A parallelogram $ABCD$ and a triangle DCE are joined as shown.
 BCE is a straight line.

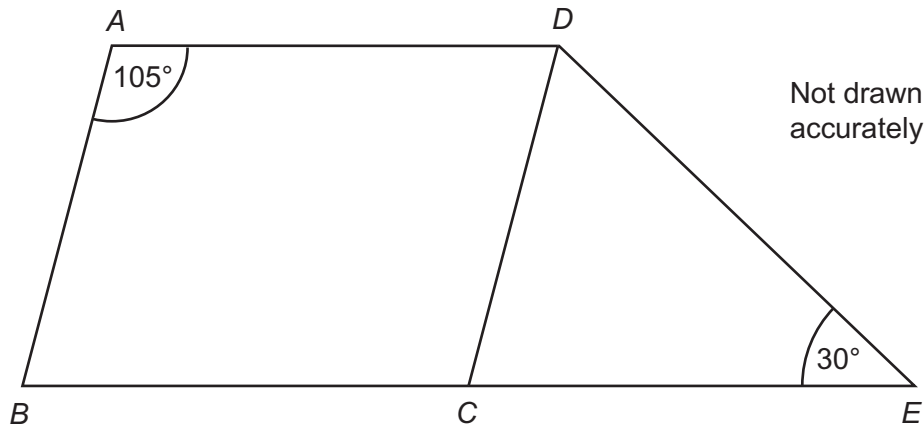

Show that DCE is an isosceles triangle.
 You **must** show your working.

[4 marks]



17

Field A is a rectangle with sides of 30 m and 70 m

Field B is a square with the same **perimeter** as Field A.



How much bigger in area is Field B than Field A?
You **must** show your working.

[4 marks]

Answer _____ m²

Turn over for the next question



18 Work out 210 as a product of its prime factors.

[2 marks]

Answer _____

19 Here are the first five terms of a linear sequence.

9 15 21 27 33 ...

Work out the n th term.

[2 marks]

Answer _____



20

Here is a regular polygon.

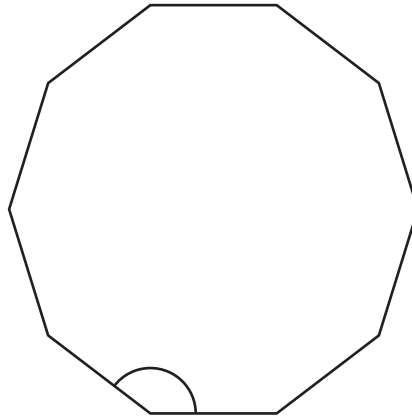
Not drawn
accurately

Work out the size of an interior angle.
You **must** show your working.

[2 marks]

Answer _____ degrees

END OF QUESTIONS

6

Turn over ►

There are no questions printed on this page

**DO NOT WRITE ON THIS PAGE
ANSWER IN THE SPACES PROVIDED**

Copyright Information

For confidentiality purposes, from the November 2015 examination series, acknowledgements of third party copyright material will be published in a separate booklet rather than including them on the examination paper or support materials. This booklet is published after each examination series and is available for free download from www.aqa.org.uk after the live examination series.

Permission to reproduce all copyright material has been applied for. In some cases, efforts to contact copyright-holders may have been unsuccessful and AQA will be happy to rectify any omissions of acknowledgements. If you have any queries please contact the Copyright Team, AQA, Stag Hill House, Guildford, GU2 7XJ.

Copyright © 2016 AQA and its licensors. All rights reserved.

