



Oxford Cambridge and RSA

Wednesday 21 October 2020 – Afternoon

A Level Further Mathematics A

Y543/01 Mechanics

Time allowed: 1 hour 30 minutes

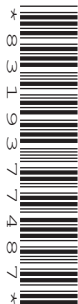

You must have:

- the Printed Answer Booklet
- the Formulae Booklet for A Level Further Mathematics A
- a scientific or graphical calculator

INSTRUCTIONS

- Use black ink. You can use an HB pencil, but only for graphs and diagrams.
- Write your answer to each question in the space provided in the **Printed Answer Booklet**. If you need extra space use the lined pages at the end of the Printed Answer Booklet. The question numbers must be clearly shown.
- Fill in the boxes on the front of the Printed Answer Booklet.
- Answer **all** the questions.
- Where appropriate, your answer should be supported with working. Marks might be given for using a correct method, even if your answer is wrong.
- Give non-exact numerical answers correct to 3 significant figures unless a different degree of accuracy is specified in the question.
- The acceleration due to gravity is denoted by $g \text{ m s}^{-2}$. When a numerical value is needed use $g = 9.8$ unless a different value is specified in the question.
- Do **not** send this Question Paper for marking. Keep in the centre or recycle it.

INFORMATION

- The total mark for this paper is **75**.
- The marks for each question are shown in brackets [].
- This document has **8** pages.

ADVICE

- Read each question carefully before you start your answer.

Answer **all** the questions.

- 1 A force of $\begin{pmatrix} 2 \\ 10 \end{pmatrix}$ N is the only horizontal force acting on a particle P of mass 1.25 kg as it moves in a horizontal plane. Initially P is at the origin, O , and 5 seconds later it is at the point A (50, 140). The units of the coordinate system are metres.
- (a) Calculate the work done by the force during these 5 seconds. [2]
- (b) Calculate the average power generated by the force during these 5 seconds. [1]

The speed of P at O is 10 m s^{-1} .

- (c) Calculate the speed of P at A . [2]

- 2 A bungee jumper of mass 80 kg steps off a high bridge with an elastic rope attached to her ankles. She is assumed to fall vertically from rest and the air resistance she experiences is modelled as a constant force of 32 N. The rope has natural length 4 m and modulus of elasticity 470 N.

By considering energy, determine the total distance she falls before first coming to instantaneous rest. [6]

- 3 One end of a light inextensible string of length 0.75 m is attached to a particle A of mass 2.8 kg. The other end of the string is attached to a fixed point O . A is projected horizontally with speed 6 m s^{-1} from a point 0.75 m vertically above O (see Fig. 3). When OA makes an angle θ with the upward vertical the speed of A is $v \text{ m s}^{-1}$.

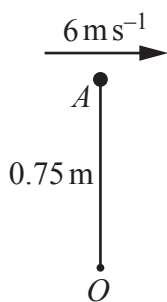

Fig. 3

- (a) Show that $v^2 = 50.7 - 14.7 \cos \theta$. [3]
- (b) Given that the string breaks when the tension in it reaches 200 N, find the angle that OA turns through between the instant that A is projected and the instant that the string breaks. [4]

- 4 The resistive force, F , on a sphere falling through a viscous fluid is thought to depend on the radius of the sphere, r , the velocity of the sphere, v , and the viscosity of the fluid, η . You are given that η is measured in $\text{N m}^{-2} \text{s}$.

(a) By considering its units, find the dimensions of viscosity. [2]

A model of the resistive force suggests the following relationship: $F = 6\pi\eta^\alpha r^\beta v^\gamma$.

(b) Explain whether or not it is possible to use dimensional analysis to verify that the constant 6π is correct. [1]

(c) Use dimensional analysis to find the values of α , β and γ . [4]

A sphere of radius r and mass m falls vertically from rest through the fluid. After a time t its velocity is v .

(d) By setting up and solving a differential equation, show that $e^{-kt} = \frac{g - kv}{g}$ where $k = \frac{6\pi\eta r}{m}$. [5]

As the time increases, the velocity of the sphere tends towards a limit called the terminal velocity.

(e) Find, in terms of g and k , the terminal velocity of the sphere. [1]

In a sequence of experiments the sphere is allowed to fall through fluids of different viscosity, ranging from small to very large, with all other conditions being constant. The terminal velocity of the sphere through each fluid is measured.

(f) Describe how, according to the model, the terminal velocity of the sphere changes as the viscosity of the fluid through which it falls increases. [2]

- 5 The cover of a children's book is modelled as being a uniform lamina L . L occupies the region bounded by the x -axis, the curve $y = 6 + \sin x$ and the lines $x = 0$ and $x = 5$ (see Fig. 5.1). The centre of mass of L is at the point (\bar{x}, \bar{y}) .

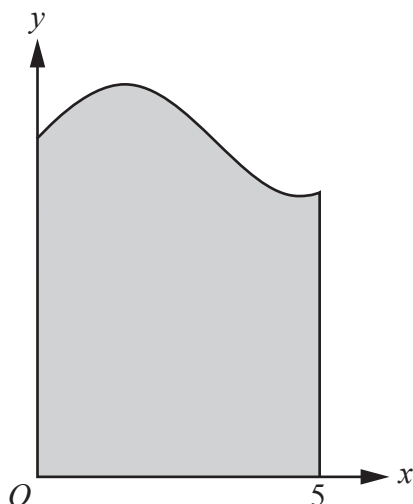

Fig. 5.1

- (a) Show that $\bar{x} = 2.36$, correct to 3 significant figures. [2]
- (b) Find \bar{y} , giving your answer correct to 3 significant figures. [2]

The cover of the book weighs 6 N. A is the point on the cover with coordinates $(3, \bar{y})$ and B is the point on the cover with coordinates $(5, \bar{y})$. A small badge of weight 2 N is attached to the cover at A .

The side of L along the y -axis is attached to the rest of the book and the book is placed on a rough horizontal plane. The attachment of the cover to the book is modelled as a hinge.

The cover is held in equilibrium at an angle of $\frac{1}{3}\pi$ radians to the horizontal by a force of magnitude PN acting at B perpendicular to the cover (see Fig. 5.2).

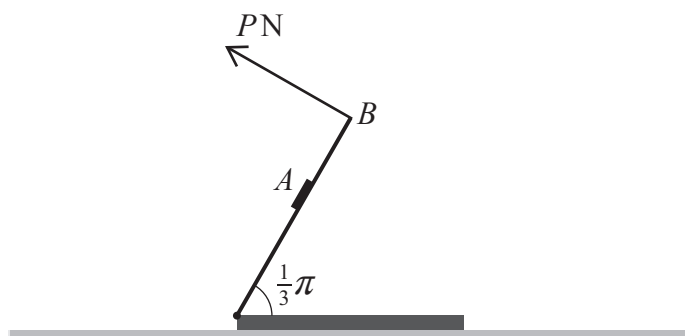

Fig. 5.2

- (c) State two additional modelling assumptions, one about the attachment of the cover and one about the badge, which are necessary to allow the value of P to be determined. [2]
- (d) Using the modelling assumptions, determine the value of P giving your answer correct to 3 significant figures. [3]

- 6 Two smooth circular discs A and B are moving on a horizontal plane. The masses of A and B are 3 kg and 4 kg respectively. At the instant before they collide
- the velocity of A is 2 m s^{-1} at an angle of 60° to the line joining their centres,
 - the velocity of B is 5 m s^{-1} towards A along the line joining their centres (see Fig. 6).

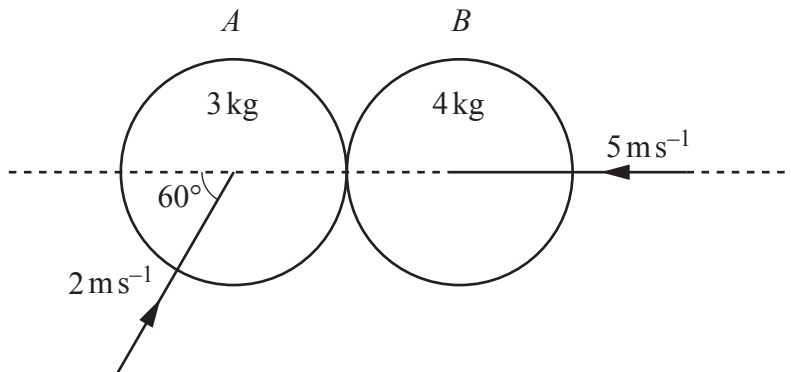

Fig. 6

Given that the velocity of A after the collision is perpendicular to the velocity of A before the collision, find

- (a) the coefficient of restitution between A and B , [7]
- (b) the total loss of kinetic energy as a result of the collision. [5]

- 7 Fig. 7.1 shows a uniform lamina in the shape of a sector of a circle of radius r and angle 2θ where θ is in radians. The sector consists of a triangle OAB and a segment bounded by the chord AB .

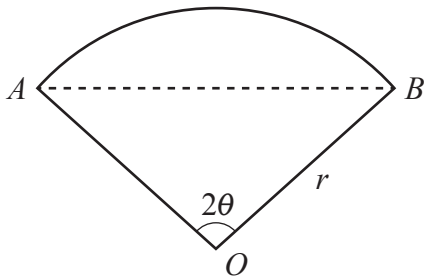

Fig. 7.1

- (a) Explain why the centre of mass of the **segment** lies on the radius through the midpoint of AB . [1]
- (b) Show that the distance of the centre of mass of the **segment** from O is $\frac{2r \sin^3 \theta}{3(\theta - \sin \theta \cos \theta)}$. [4]

A uniform circular lamina of radius 5 units is placed with its centre at the origin, O , of an x - y coordinate system. A component for a machine is made by removing and discarding a segment from the lamina. The radius of the circle from which the segment is formed is 3 units and the centre of this circle is O . The centre of the straight edge of the segment has coordinates $(0, 2)$ and this edge is perpendicular to the y -axis (see Fig. 7.2).

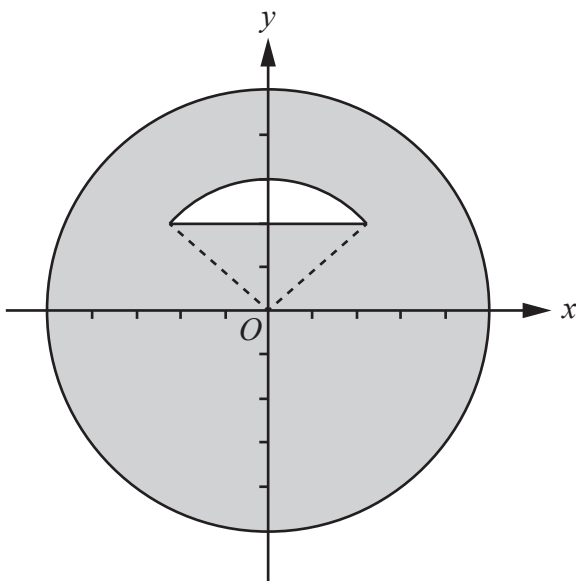

Fig. 7.2

- (c) Find the y -coordinate of the centre of mass of the component, giving your answer correct to 3 significant figures. [5]

C is the point on the component with coordinates $(0, 5)$. The component is now placed horizontally and supported only at O . A particle of mass m kg is placed on the component at C and the component and particle are in equilibrium.

- (d) Find the mass of the component in terms of m . [2]

- 8 One end of a light elastic string of natural length l m and modulus of elasticity λ N is attached to a particle A of mass m kg. The other end of the string is attached to a fixed point O which is on a horizontal surface. The surface is modelled as being smooth and A moves in a circular path around O with **constant speed** v ms^{-1} . The extension of the string is denoted by x m.
- (a) Show that x satisfies $\lambda x^2 + \lambda lx - lm v^2 = 0$. [3]
- (b) By solving the equation in part (a) and using a binomial series, show that if λ is very large then $\lambda x \approx m v^2$. [3]
- (c) By considering the tension in the string, explain how the result obtained when λ is very large relates to the situation when the string is inextensible. [1]

The nature of the horizontal surface is such that the modelling assumption that it is smooth is justifiable provided that the speed of the particle does not exceed 7ms^{-1} .

In the case where $m = 0.16$ and $\lambda = 260$, the extension of the string is measured as being 3.0 cm.

- (d) Estimate the value of v . [1]
- (e) Explain whether the value of v means that the modelling assumption is necessarily justifiable in this situation. [1]

END OF QUESTION PAPER

OCR

Oxford Cambridge and RSA

Copyright Information

OCR is committed to seeking permission to reproduce all third-party content that it uses in its assessment materials. OCR has attempted to identify and contact all copyright holders whose work is used in this paper. To avoid the issue of disclosure of answer-related information to candidates, all copyright acknowledgements are reproduced in the OCR Copyright Acknowledgements Booklet. This is produced for each series of examinations and is freely available to download from our public website (www.ocr.org.uk) after the live examination series.

If OCR has unwittingly failed to correctly acknowledge or clear any third-party content in this assessment material, OCR will be happy to correct its mistake at the earliest possible opportunity.

For queries or further information please contact The OCR Copyright Team, The Triangle Building, Shaftesbury Road, Cambridge CB2 8EA.

OCR is part of the Cambridge Assessment Group; Cambridge Assessment is the brand name of University of Cambridge Local Examinations Syndicate (UCLES), which is itself a department of the University of Cambridge.