

Please write clearly in block capitals.

Centre number

--	--	--	--	--

Candidate number

--	--	--	--

Surname

Forename(s)

Candidate signature

A-level PHYSICS

Paper 3 Section A

Thursday 29 June 2017

Morning

Time allowed: The total time for both sections of this paper is 2 hours. You are advised to spend approximately 70 minutes on this section.

Materials

For this paper you must have:

- a pencil and a ruler
- a scientific calculator
- a Data and Formulae booklet.

Instructions

- Use black ink or black ball-point pen.
- Fill in the boxes at the top of this page.
- Answer **all** questions.
- You must answer the questions in the spaces provided. Do not write outside the box around each page or on blank pages.
- Do all rough work in this book. Cross through any work you do not want to be marked.
- Show all your working.

Information

- The marks for questions are shown in brackets.
- The maximum mark for this paper is 45.
- You are expected to use a scientific calculator where appropriate.
- A Data and Formulae Booklet is provided as a loose insert.

For Examiner's Use	
Question	Mark
1	
2	
3	
TOTAL	



Section A

Answer **all** questions in this section.

0 1

This question is about an experiment to measure the wavelength of microwaves.

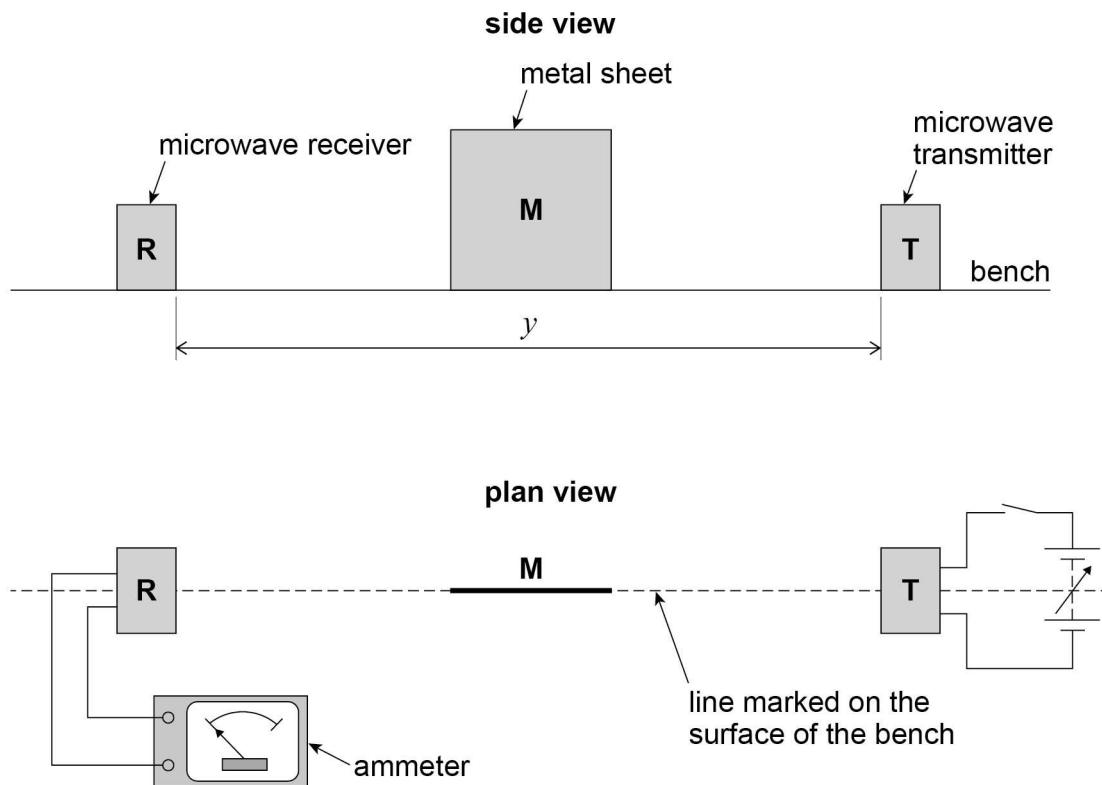
A microwave transmitter **T** and a receiver **R** are arranged on a line marked on the bench.

A metal sheet **M** is placed on the marked line perpendicular to the bench surface.

Figure 1 shows side and plan views of the arrangement.

The circuit connected to **T** and the ammeter connected to **R** are only shown in the plan view.

Figure 1

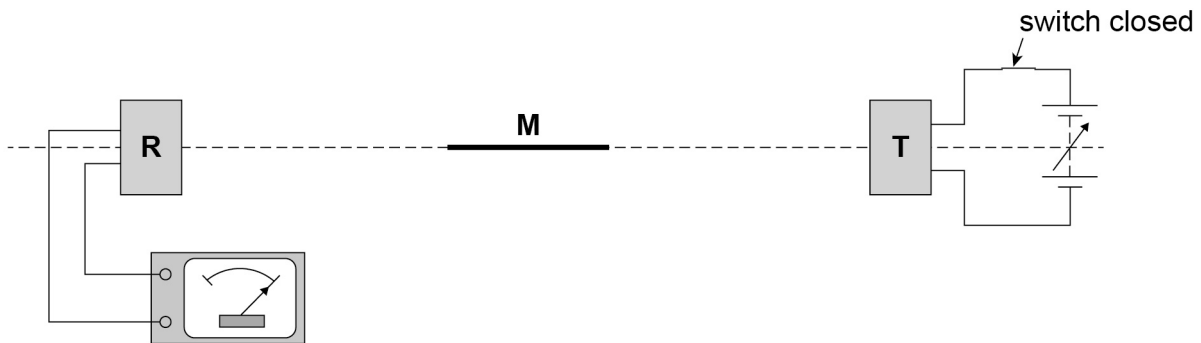


The distance y between **T** and **R** is recorded.



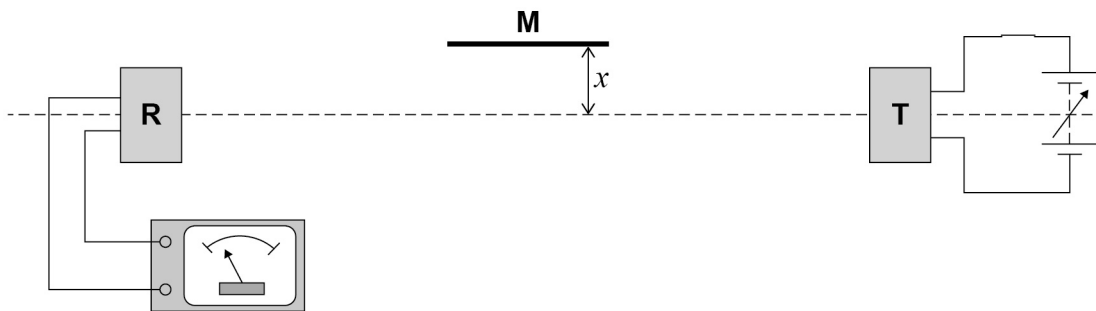
T is switched on and the output from **T** is adjusted so a reading is produced on the ammeter as shown in **Figure 2**.

Figure 2



M is kept parallel to the marked line and moved slowly away as shown in **Figure 3**.

Figure 3



The reading decreases to a minimum reading **which is not zero**.
The perpendicular distance x between the marked line and **M** is recorded.

0 1 . 1

The ammeter reading depends on the superposition of waves travelling directly to **R** and other waves that reach **R** after reflection from **M**.

State the phase difference between the sets of waves superposing at **R** when the ammeter reading is a **minimum**.

Give a suitable unit with your answer.

[1 mark]

Question 1 continues on the next page

Turn over ►



0 1 . 2

Explain why the minimum reading is **not** zero when the distance x is measured.

[1 mark]

0 1 . 3

When **M** is moved further away the reading increases to a maximum then decreases to a minimum.

At the first minimum position, a student labels the minimum $n = 1$ and records the value of x .

The next minimum position is labelled $n = 2$ and the new value of x is recorded. Several positions of maxima and minima are produced.

Describe a procedure that the student could use to make sure that **M** is parallel to the marked line before measuring each value of x .

You may wish to include a sketch with your answer.

[2 marks]



Question 1 continues on the next page

**DO NOT WRITE ON THIS PAGE
ANSWER IN THE SPACES PROVIDED**

Turn over ►



0 1 . 4

It can be shown that

$$n\lambda = \sqrt{4x^2 + y^2} - y$$

where λ is the wavelength of the microwaves and y is the distance defined in **Figure 1**.

The student plots the graph shown in **Figure 4**.

The student estimates the uncertainty in each value of $\sqrt{4x^2 + y^2}$ to be 0.025 m and adds error bars to the graph.

Determine

- the maximum gradient G_{\max} of a line that passes through all the error bars
- the minimum gradient G_{\min} of a line that passes through all the error bars.

[3 marks]

$$G_{\max} = \underline{\hspace{10cm}}$$

$$G_{\min} = \underline{\hspace{10cm}}$$

0 1 . 5

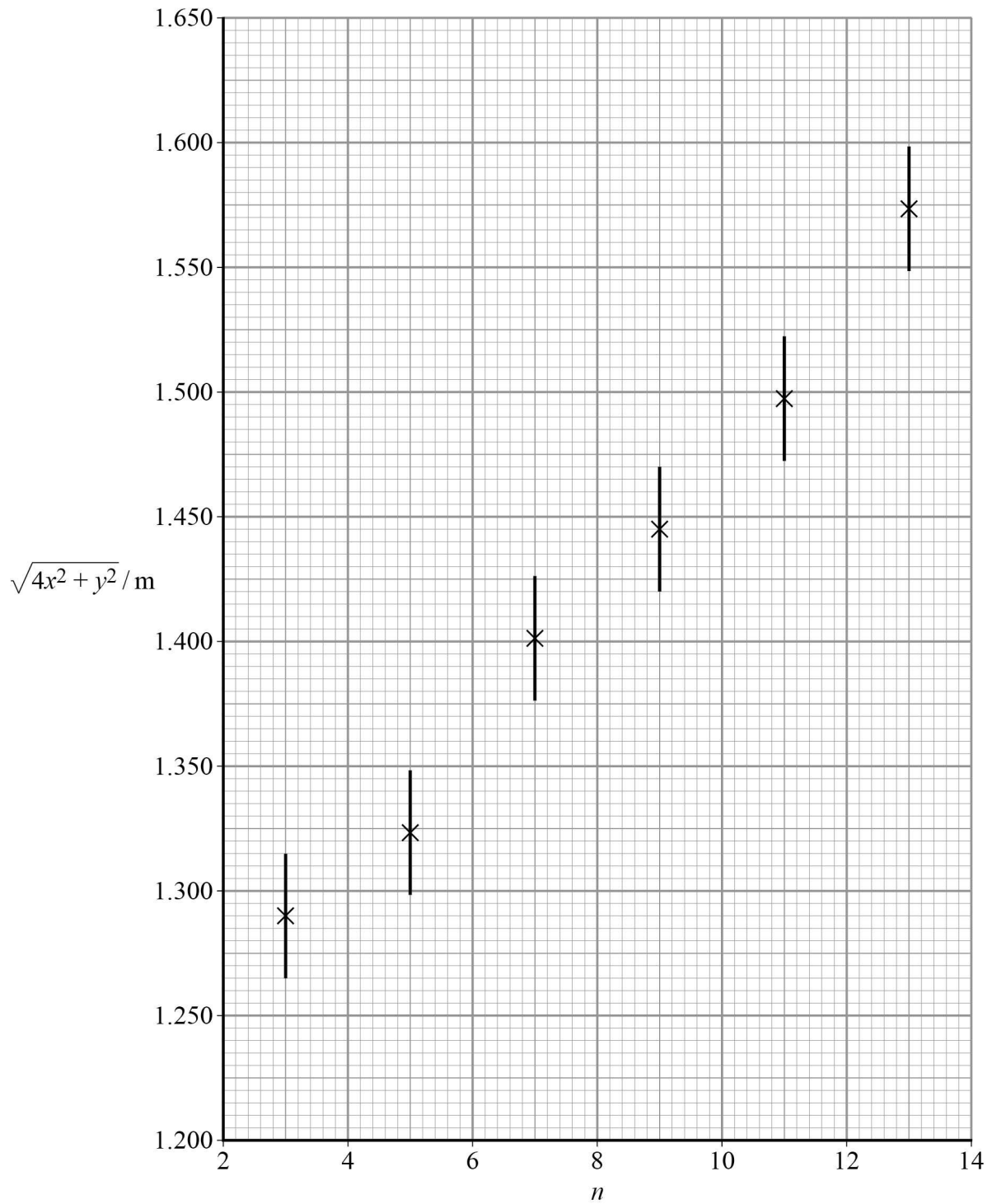
Determine λ using your results for G_{\max} and G_{\min} .

[2 marks]

$$\lambda = \underline{\hspace{10cm}} \text{ m}$$



Figure 4



Question 1 continues on the next page

Turn over ►



0 1 . 6

Determine the percentage uncertainty in your result for λ .**[3 marks]**percentage uncertainty in $\lambda =$ _____ %

0 1 . 7

Explain how the graph in **Figure 4** can be used to obtain the value of y .
You are **not** required to determine y .**[2 marks]**

0 1 . 8

Suppose that the data for $n = 13$ had not been plotted on **Figure 4**.Add a tick (\checkmark) in each row of **Table 1** to identify the effect, if any, on the results you would obtain for G_{\max} , G_{\min} , λ and y .**[4 marks]****Table 1**

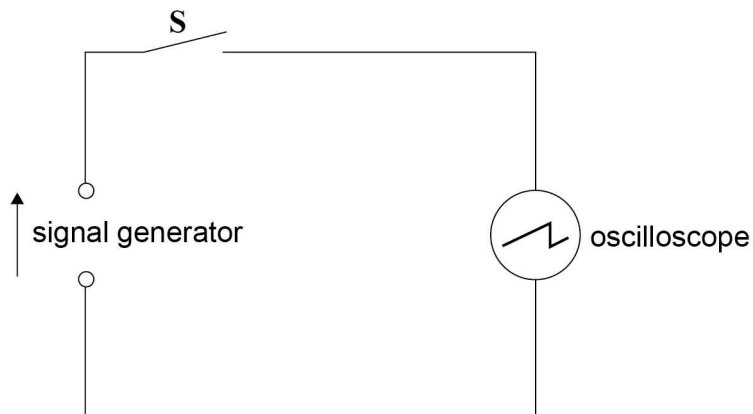
Result	Reduced	Not affected	Increased
G_{\max}			
G_{\min}			
λ			
y			



0 2

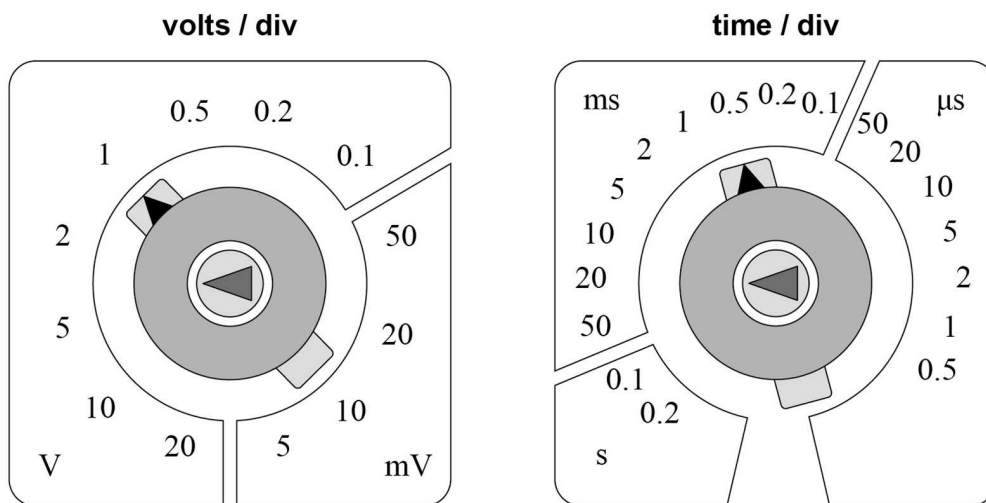
A signal generator is connected to an oscilloscope, as shown in **Figure 5**.

Figure 5



The Y-voltage gain and time-base settings of the oscilloscope are shown in **Figure 6**.

Figure 6



Question 2 continues on the next page

Turn over ►



When switch S is open (off) the oscilloscope displays the waveform shown in **Figure 7**.

When S is closed (on) the oscilloscope displays the waveform shown in **Figure 8**.

0 2 . 1

Determine the peak-to-peak voltage V of the waveform shown in **Figure 8**.

[1 mark]

$$V = \text{_____} \text{ V}$$

0 2 . 2

Determine the frequency f of the waveform shown in **Figure 8**.

[2 marks]

$$f = \text{_____} \text{ Hz}$$



Figure 7

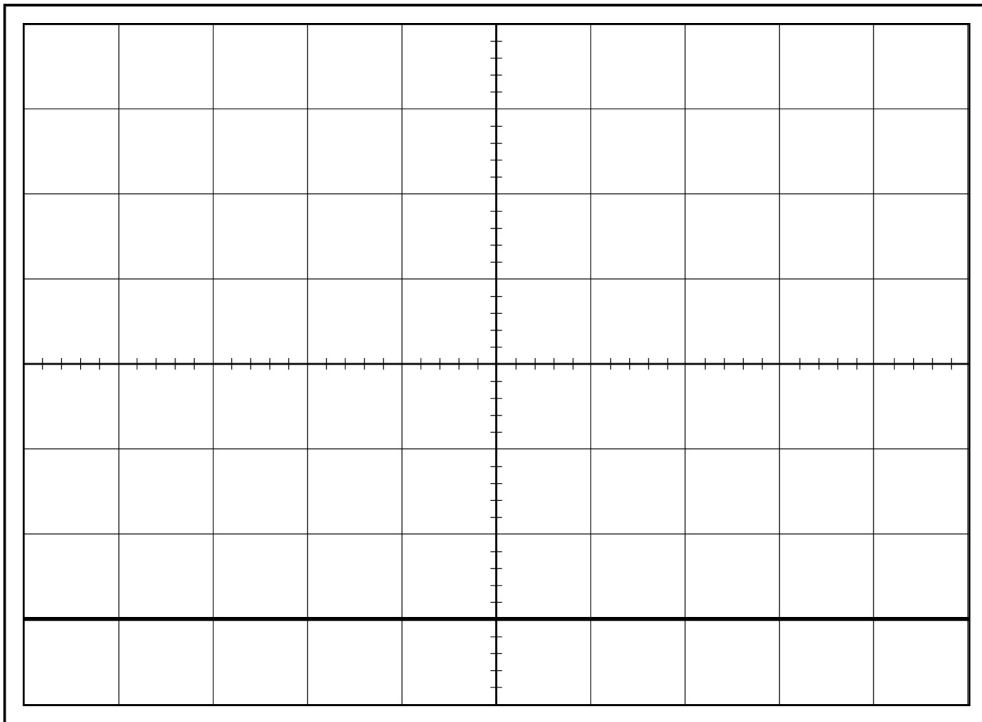
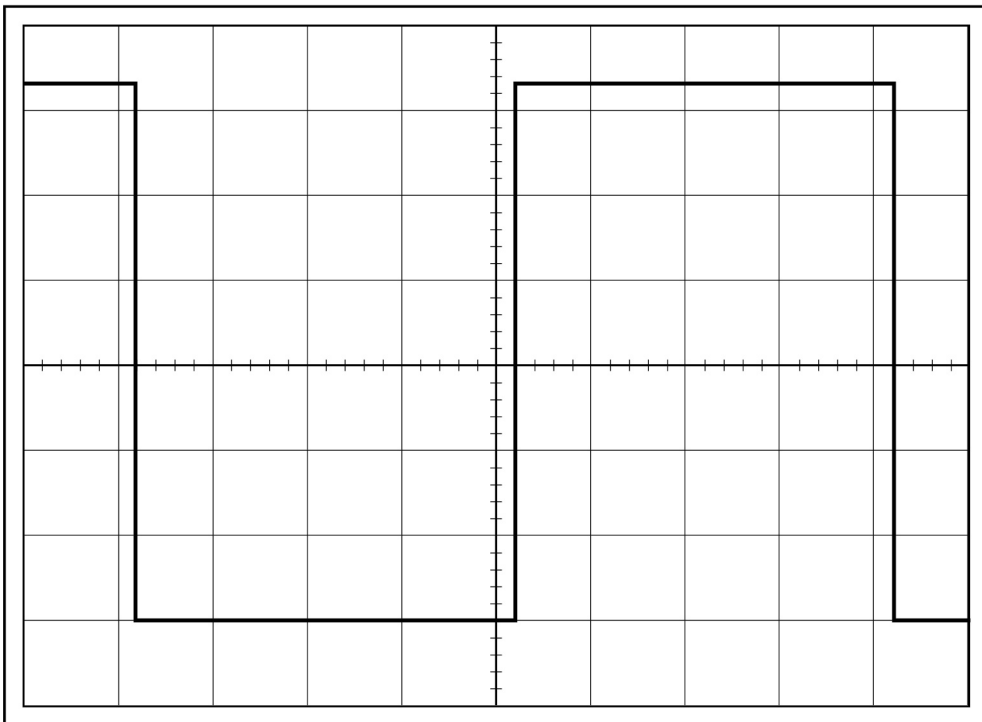


Figure 8



Question 2 continues on the next page

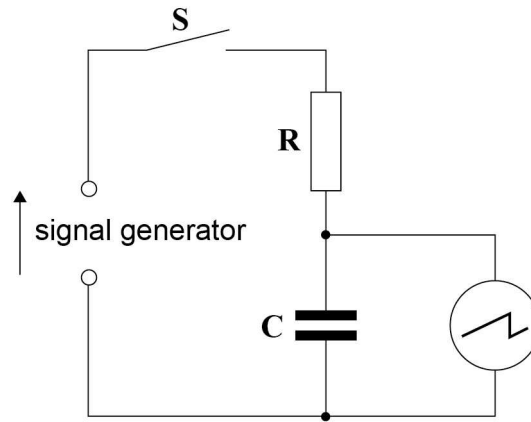
Turn over ►



0 2 . 3

Figure 9 shows the signal generator connected in series with a resistor **R** and a capacitor **C**.

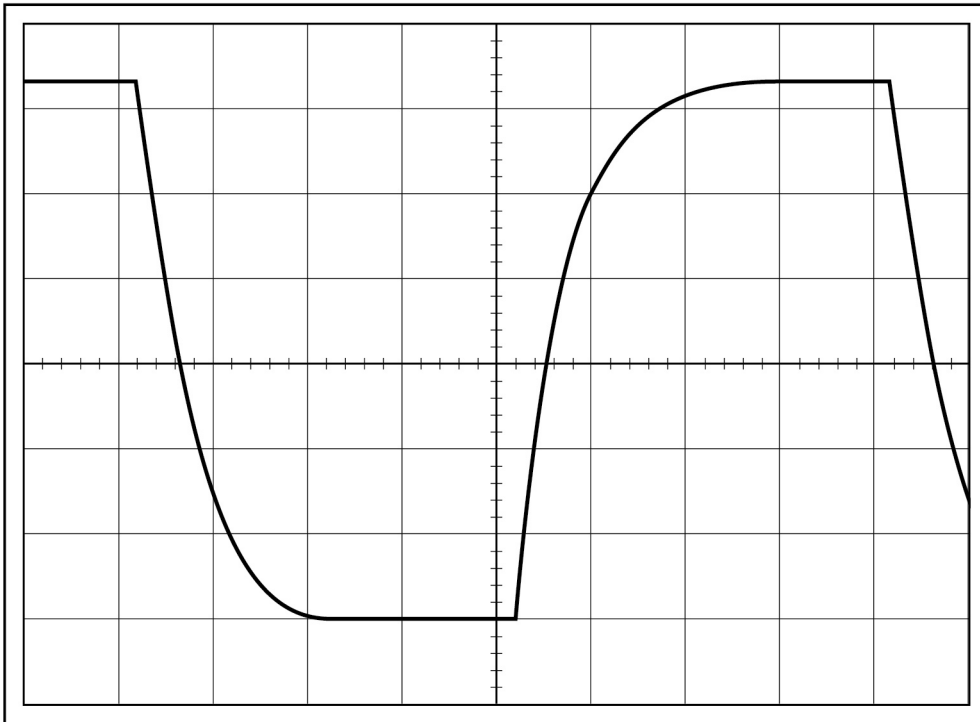
Figure 9



The oscilloscope is connected across the capacitor.
The Y-voltage gain and time-base settings are still the same as shown in **Figure 6**.

When **S** is closed (on) the oscilloscope displays the waveform shown in **Figure 10**.

Figure 10



Determine the time constant of the circuit in **Figure 9**.

[2 marks]

time constant = _____ s

0 2 . 4

A student suggests that setting the time-base to $0.2 \text{ ms division}^{-1}$ might reduce uncertainty in the determination of the time constant.

State and explain any possible advantage or disadvantage in making this suggested adjustment.

[3 marks]

Question 2 continues on the next page

Turn over ►



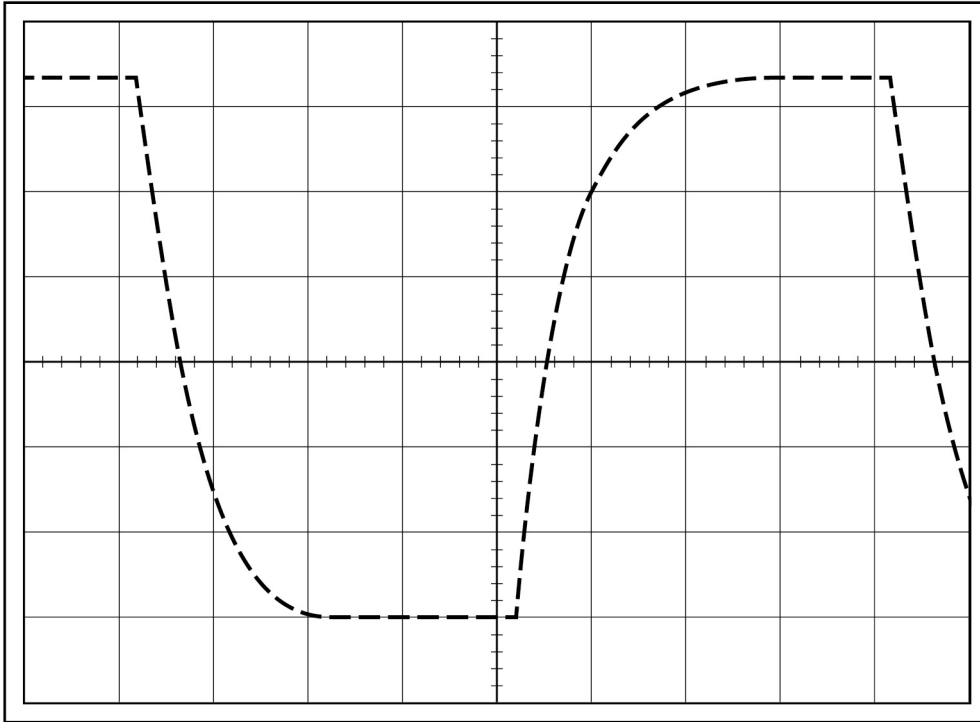
0 2 . 5

The student connects an identical resistor in parallel with R and uses the oscilloscope to display the waveform across C .

Draw on **Figure 11** the waveform you expect the student to see.

The waveform of **Figure 10** is shown as a dashed line to help you show how the waveform changes.

Figure 11



Explain the change in the waveform.

[2 marks]



0 2 . 6

Figure 12a is a graph of voltage against time showing the output of the signal generator. **Figure 12b** shows the voltage across **C** during the same time interval.

The student interchanges the positions of **R** and **C** and connects the oscilloscope across **R**.

Complete **Figure 12c** to draw the voltage across **R** during the time interval.

[2 marks]

Figure 12a

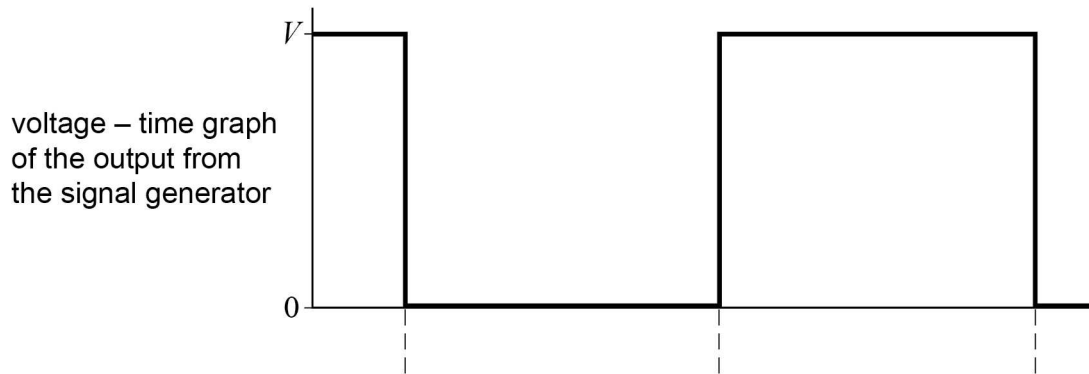


Figure 12b

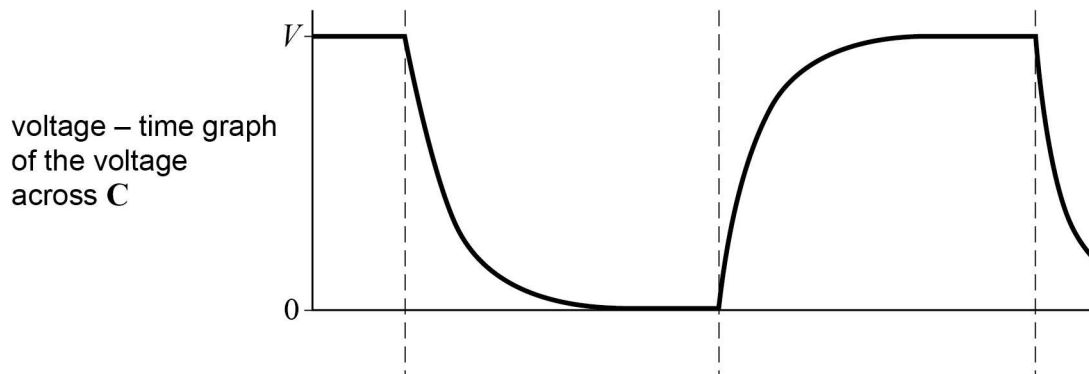
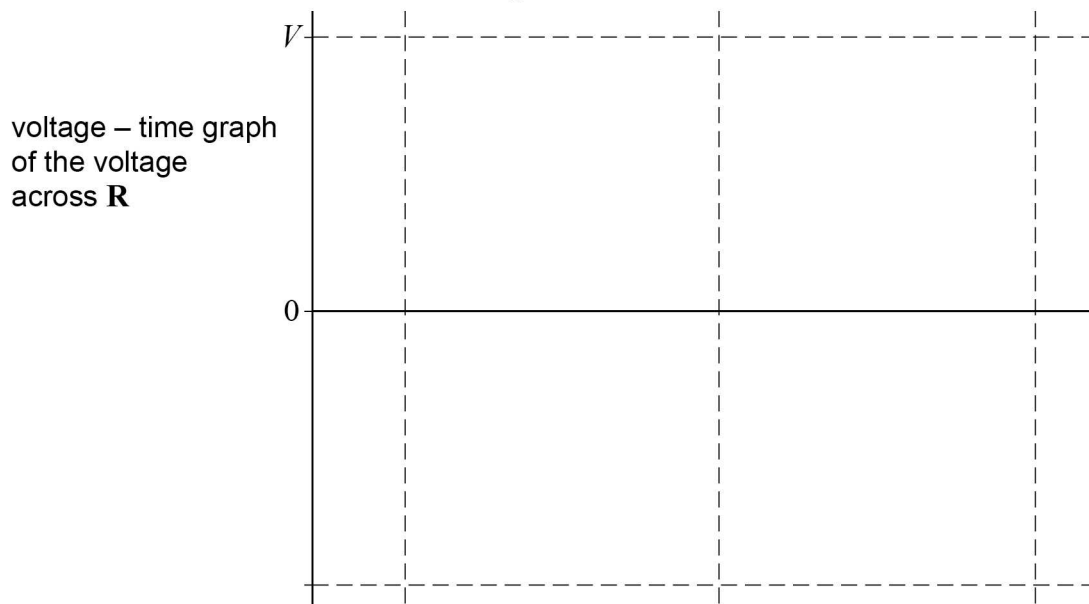


Figure 12c



Question 2 continues on the next page

Turn over ►



0 2 . 7

State and explain what changes, if any, the student needs to make to the settings of the oscilloscope so the waveform across **R** is fully displayed.

[2 marks]

14

Turn over for the next question

**DO NOT WRITE ON THIS PAGE
ANSWER IN THE SPACES PROVIDED**

Turn over ►



0 3

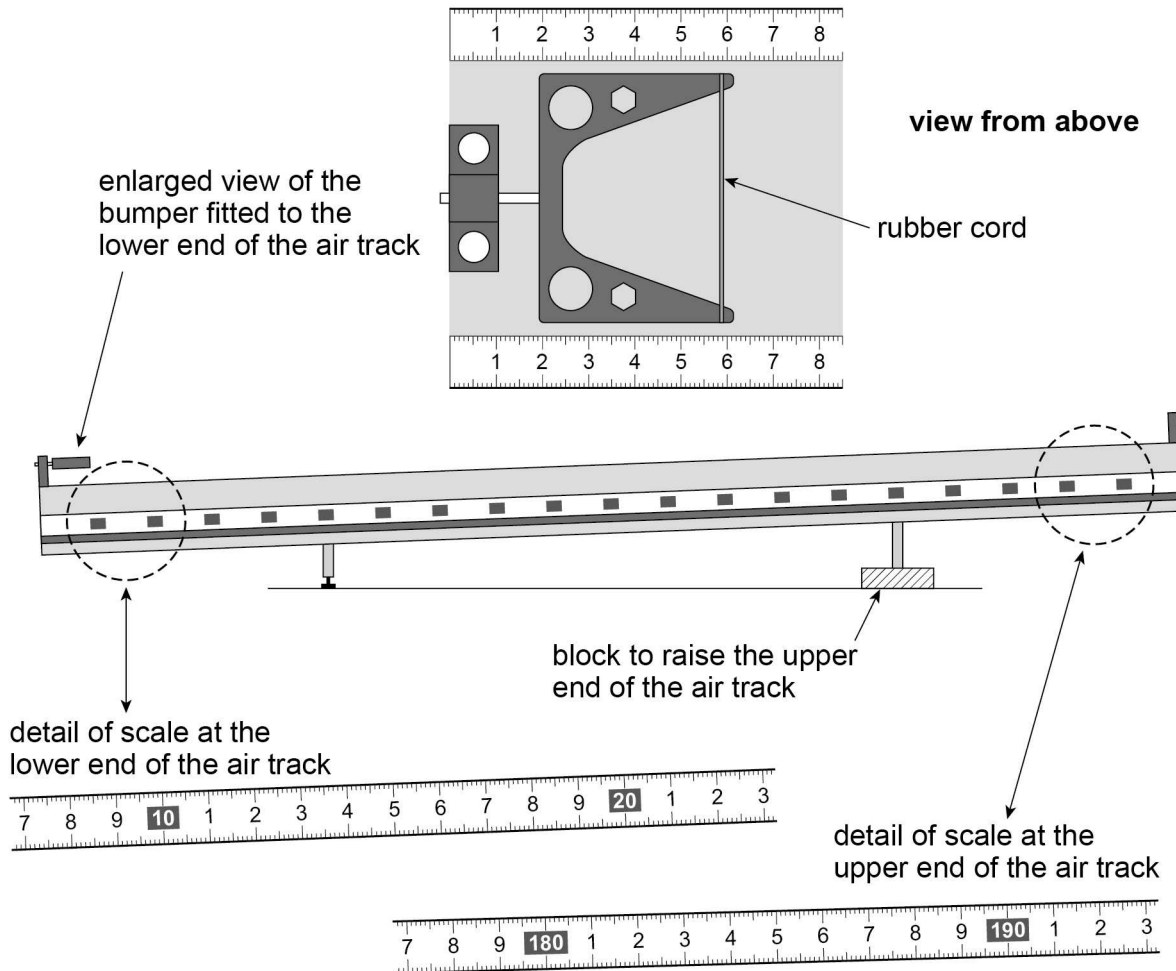
This question is about an experiment with a linear air track.

A block is used to raise one end of the track.

A bumper fitted with a rubber cord is attached at the lower end of the track.

The air track has a length of 2 m and there is a scale with major divisions marked in centimetres along the side; the zero of the scale is at the lower end, as shown in **Figure 13**.

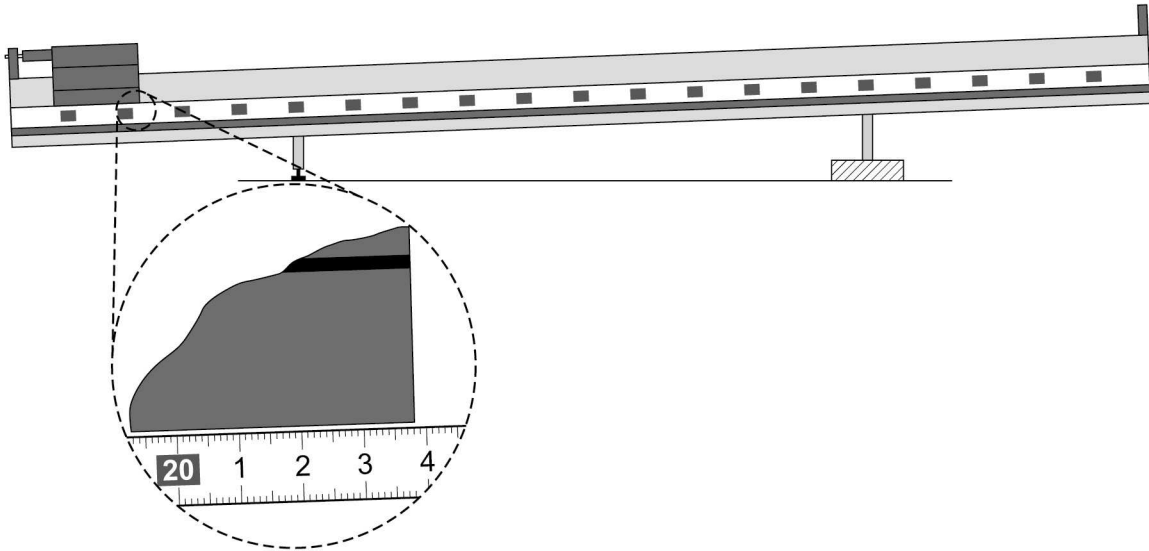
Figure 13



A glider is placed in contact with the rubber cord on the bumper at the lower end of the track. The position of the glider relative to the fixed scale can be determined using **Figure 14**.

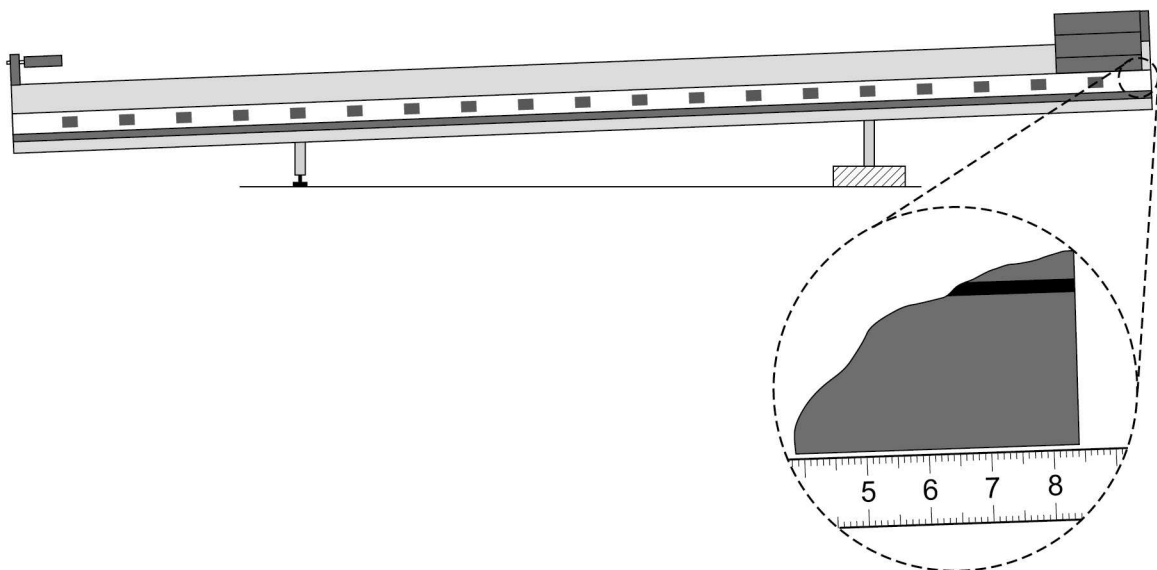


Figure 14



The glider is then moved to the position shown in **Figure 15**.

Figure 15



The air supply to the track is turned on and the glider is released. The glider accelerates down the track, strikes the rubber cord on the bumper and rebounds back up the track. The glider is allowed to bounce off the rubber band 20 times before it is stopped.

A student reads and records the highest position p of the glider after each rebound n .

Some of the student's data are shown in **Table 2**.

Additional columns have been provided to allow you to complete question **03.2** and question **03.3**.

Question 3 continues on the next page

Turn over ►



Table 2

n	p/cm	x/cm	$\ln(x/\text{cm})$
0			
2	157.0		
4	125.4		
6	101.3		
9	75.4		
13	53.8		

0 3 . 1

The value of p corresponding to $n = 0$ is the glider's initial position at the top of the track.

Deduce this value of p using **Figure 13** and **Figure 15**.
Write this result in **Table 2**.

[1 mark]

0 3 . 2

As it travels from the lower end of the track to each position p the glider moves through a distance x .

Deduce x for **all** the values of n using **Figure 14**.
Write these results in **Table 2**.

[1 mark]

0 3 . 3

Plot on **Figure 16** a graph of $\ln(x/\text{cm})$ against n .

Record your values of $\ln(x/\text{cm})$ in **Table 2**.

[3 marks]

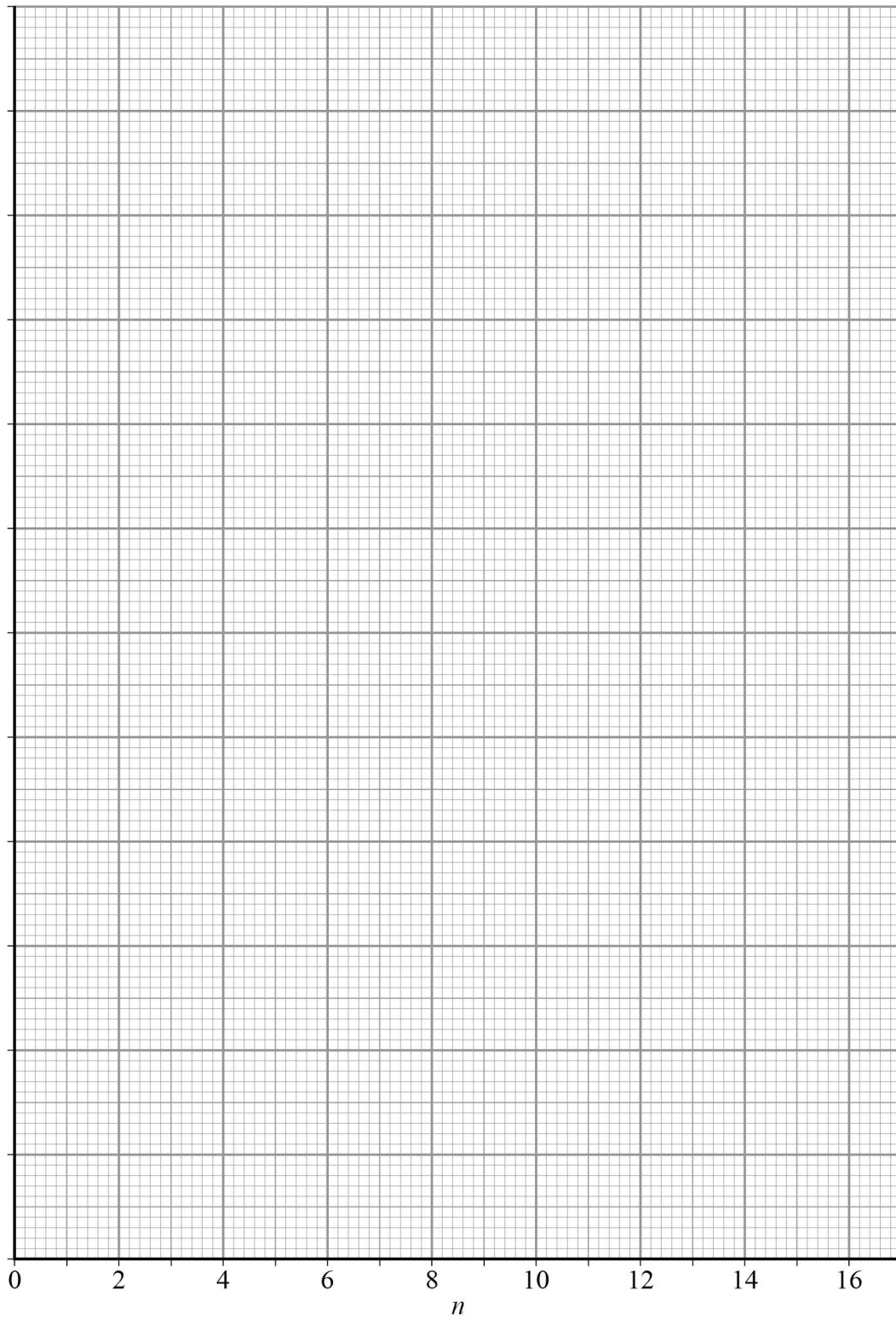
0 3 . 4

Explain why the graph you plotted confirms that x decreases exponentially with n .

[1 mark]



Figure 16



Question 3 continues on the next page

Turn over ►



0 3 . 5

Determine, using your graph in **Figure 16**, the value of x when n is 20.**[3 marks]** x when n is 20 = _____ cm

0 3 . 6

Describe and explain **two** procedures the student should take to reduce uncertainty in the measurements of p .**[4 marks]**

procedure 1 _____

procedure 2 _____

END OF QUESTIONS

13



There are no questions printed on this page

**DO NOT WRITE ON THIS PAGE
ANSWER IN THE SPACES PROVIDED**



There are no questions printed on this page

**DO NOT WRITE ON THIS PAGE
ANSWER IN THE SPACES PROVIDED**

Copyright Information

For confidentiality purposes, from the November 2015 examination series, acknowledgements of third party copyright material will be published in a separate booklet rather than including them on the examination paper or support materials. This booklet is published after each examination series and is available for free download from www.aqa.org.uk after the live examination series.

Permission to reproduce all copyright material has been applied for. In some cases, efforts to contact copyright-holders may have been unsuccessful and AQA will be happy to rectify any omissions of acknowledgements. If you have any queries please contact the Copyright Team, AQA, Stag Hill House, Guildford, GU2 7XJ.

Copyright © 2017 AQA and its licensors. All rights reserved.

