

Please write clearly in block capitals.

Centre number

|  |  |  |  |  |
|--|--|--|--|--|
|  |  |  |  |  |
|--|--|--|--|--|

Candidate number

|  |  |  |  |
|--|--|--|--|
|  |  |  |  |
|--|--|--|--|

Surname

---

Forename(s)

---

Candidate signature

---

# GCSE MATHEMATICS

# F

Foundation Tier Unit 3 Geometry and Algebra

---

Tuesday 14 June 2016

Morning

Time allowed: 1 hour 30 minutes

## Materials

For this paper you must have:

- a calculator
- mathematical instruments.



## Instructions

- Use black ink or black ball-point pen. Draw diagrams in pencil.
- Answer **all** questions.
- You must answer the questions in the spaces provided. Do not write outside the box around each page or on blank pages.
- Do all rough work in this book.
- If your calculator does not have a  $\pi$  button, take the value of  $\pi$  to be 3.14 unless another value is given in the question.

## Information

- The marks for questions are shown in brackets.
- The maximum mark for this paper is 80.
- Quality of your written communication is specifically assessed in Questions 15 and 18. These questions are indicated with an asterisk (\*).
- You may ask for more answer paper, graph paper and tracing paper. These must be tagged securely to this answer book.

## Advice

- In all calculations, show clearly how you work out your answer.
- 



**Formulae Sheet: Foundation Tier**

**Area of trapezium** =  $\frac{1}{2}(a+b)h$

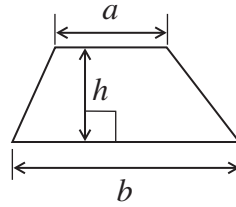

**Volume of prism** = area of cross-section  $\times$  length

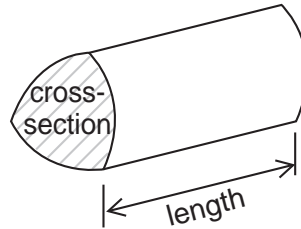

Answer **all** questions in the spaces provided.

**1** Triangle *ABC* is shown on this centimetre grid.

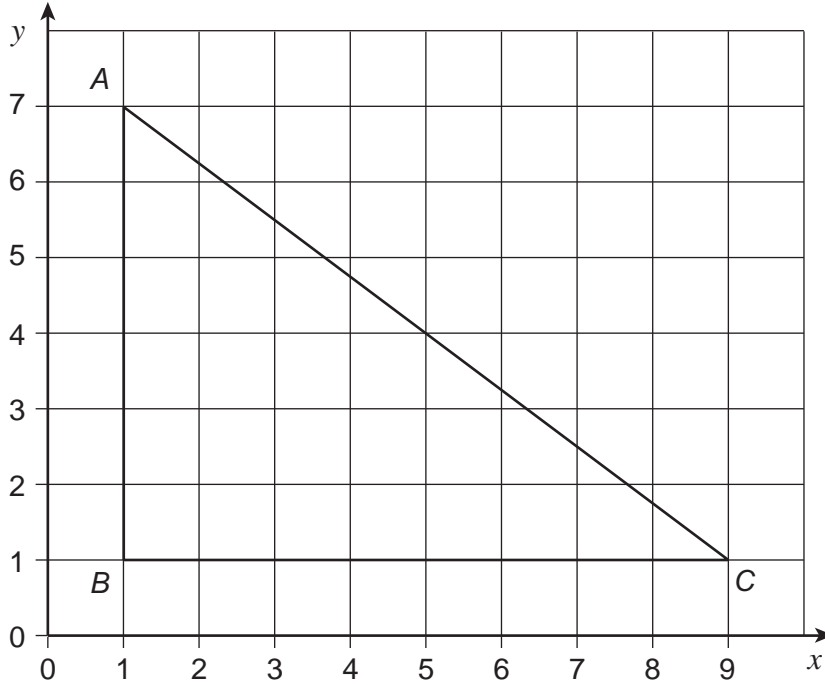

**1 (a)** Measure the length of the side *AC*.  
Give your answer in centimetres.

**[1 mark]**

Answer \_\_\_\_\_ cm

**1 (b)** Work out the perimeter of the triangle.

**[2 marks]**

\_\_\_\_\_

\_\_\_\_\_

Answer \_\_\_\_\_ cm



2 Here are five shapes.

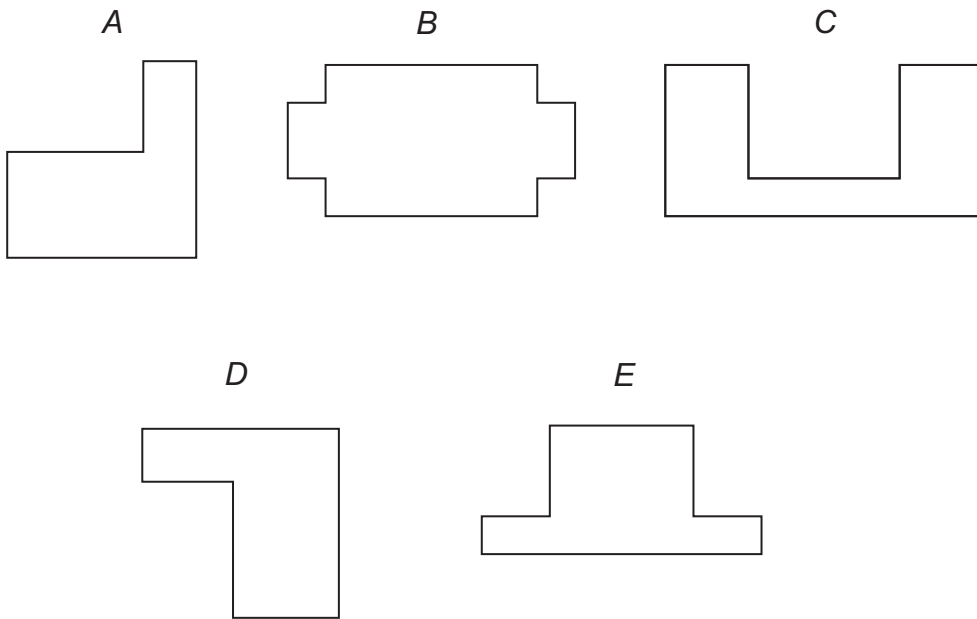

2 (a) Which shape has the most vertices?  
Circle your answer.

[1 mark]

A                      B                      C                      D                      E

2 (b) Which **two** shapes are octagons?  
Circle your answers.

[1 mark]

A                      B                      C                      D                      E

2 (c) Which **two** shapes are congruent?  
Circle your answers.

[1 mark]

A                      B                      C                      D                      E



3 A, B, C, D and E are square grids.  
Some squares have been shaded in each grid.

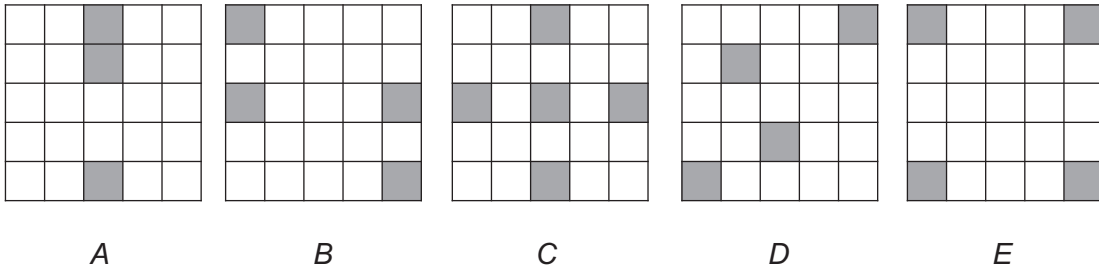

3 (a) Which **two** grids have four lines of symmetry?

[2 marks]

Answer \_\_\_\_\_ and \_\_\_\_\_

3 (b) Which **three** grids have rotational symmetry?

[2 marks]

Answer \_\_\_\_\_ and \_\_\_\_\_ and \_\_\_\_\_

3 (c) Which grid has line symmetry but **not** rotational symmetry?

[1 mark]

Answer \_\_\_\_\_



4 Here is a map.

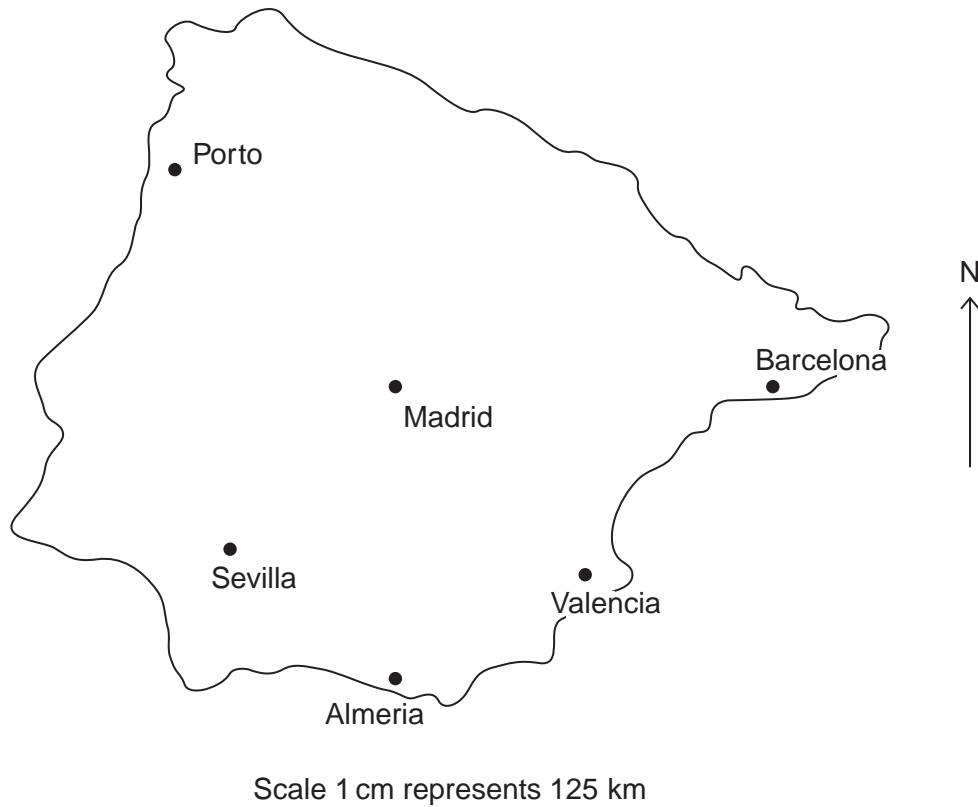

4 (a) Which city on the map is South-West of Madrid?  
Circle your answer.

[1 mark]

Porto

Sevilla

Almeria

Valencia

Barcelona



- 4 (b)** Which city on the map is North-East of Valencia?  
Circle your answer.

[1 mark]

Porto      Sevilla      Almeria      Madrid      Barcelona

- 4 (c)** The scale of the map is 1 cm represents 125 km  
Work out the actual distance between Barcelona and Madrid.

[3 marks]

---

---

---

Answer \_\_\_\_\_ km

**Turn over for the next question**



- 5 The diagram shows some flour on weighing scales.

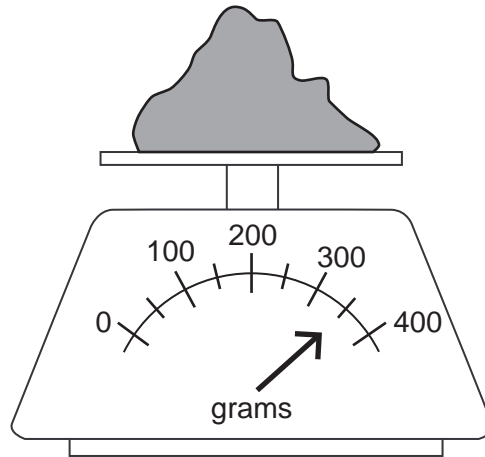

- 5 (a) How much does the flour weigh?

[1 mark]

Answer \_\_\_\_\_ grams

- 5 (b) Gino needs 0.6 kilograms of flour.  
The scales can weigh up to 400 grams.

How can he use the scales to weigh 0.6 kilograms of flour?

[2 marks]

---

---

---





6 (a) What fraction of this square grid is shaded?

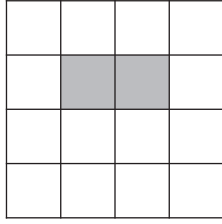

Circle the **two** correct answers.

[2 marks]

$\frac{1}{7}$

$\frac{1}{8}$

$\frac{2}{14}$

$\frac{2}{16}$

$\frac{7}{8}$

$\frac{14}{16}$

6 (b) The diagram shows a square grid.

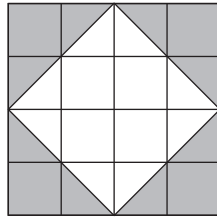

What percentage of this grid is shaded?

[2 marks]

---



---

Answer \_\_\_\_\_ %



7 Paint is sold in 5-litre tins and 10-litre tins.



£26.00



£45.50

7 (a) A decorator buys four 10-litre tins.

How many 5-litre tins could she buy for the same amount?  
You **must** show your working.

[3 marks]

---

---

---

---

---

---

---

Answer \_\_\_\_\_



**7 (b)** Dan buys five tins of paint for £169

How many tins of each size does he buy?

**[2 marks]**

---

---

---

---

---

---

---

Answer \_\_\_\_\_ 5-litre tins

and \_\_\_\_\_ 10-litre tins

**Turn over for the next question**



- 8  $ABCD$  is a rhombus.  
 $AC$  is parallel to the  $x$ -axis.

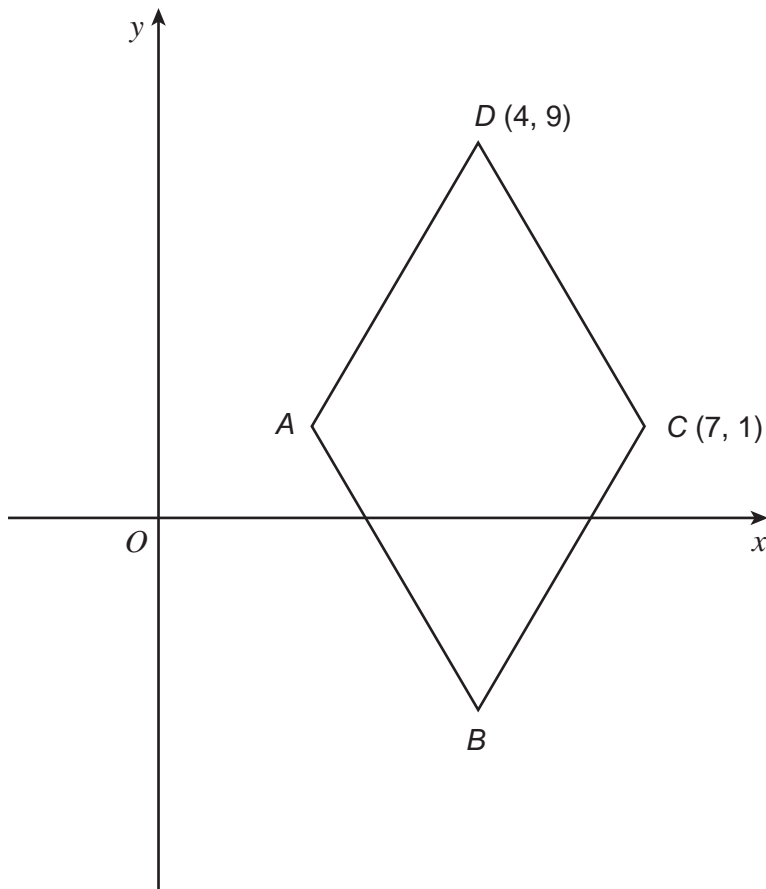

Not drawn accurately

- 8 (a) Work out the coordinates of  $A$ .

[2 marks]

Answer ( \_\_\_\_\_ , \_\_\_\_\_ )

- 8 (b) Work out the coordinates of  $B$ .

[2 marks]

Answer ( \_\_\_\_\_ , \_\_\_\_\_ )



- 9 The diagram shows a water tank in the shape of a cuboid.

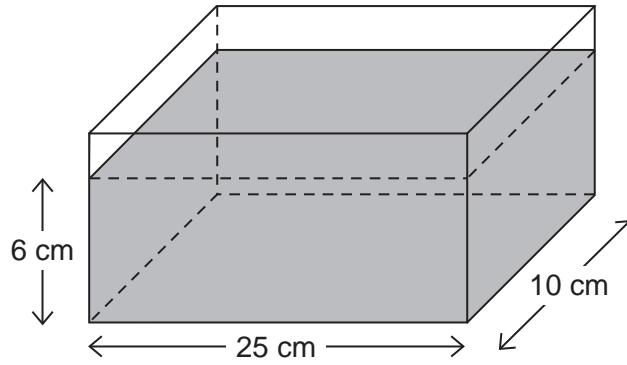

The height of the water in the tank is 6 cm  
Water leaks from the bottom of the tank at the rate of  $30 \text{ cm}^3$  per minute.

How many minutes will it take the tank to empty?

**[3 marks]**

---

---

---

---

---

---

---

---

Answer \_\_\_\_\_ minutes



**10** 10 square metres = 12 square yards

**10 (a)** Draw a conversion graph between square metres and square yards.

**[2 marks]**

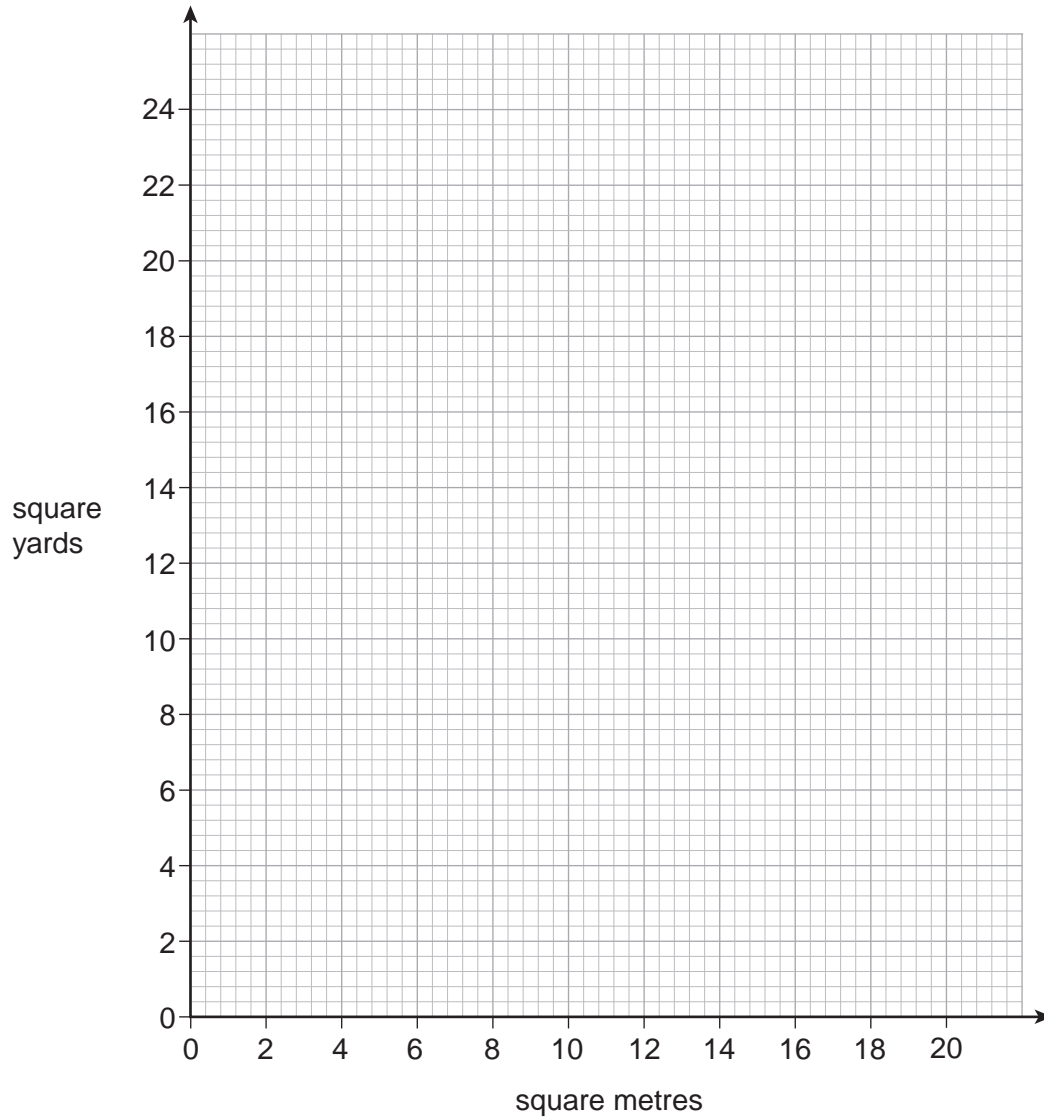

**10 (b)** How many square metres are equal to 18 square yards?  
Circle your answer.

**[1 mark]**

15

16

21

22



**10 (c)** The value of a piece of land is worked out using the formula

$$V = 25A$$

$V$  is the value in £

$A$  is the area of the land in square **yards**.

The area of a piece of land is 400 square **metres**.

Work out the value of the piece of land.

**[3 marks]**

---

---

---

---

Answer £ \_\_\_\_\_

**Turn over for the next question**



11 (a) Reflect this triangle in the line  $y = 4$

[2 marks]

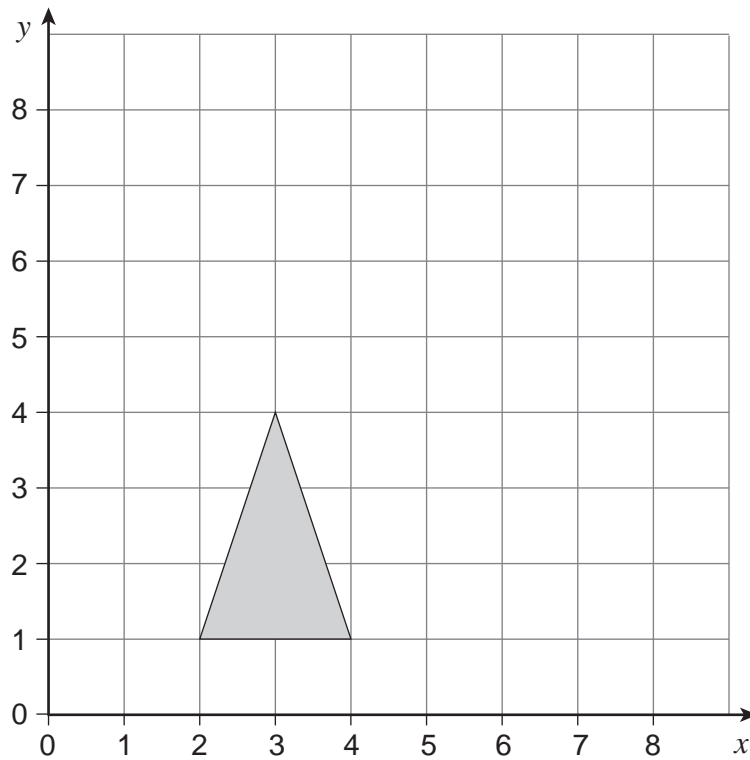



11 (b) Enlarge this shape by scale factor 3

[2 marks]

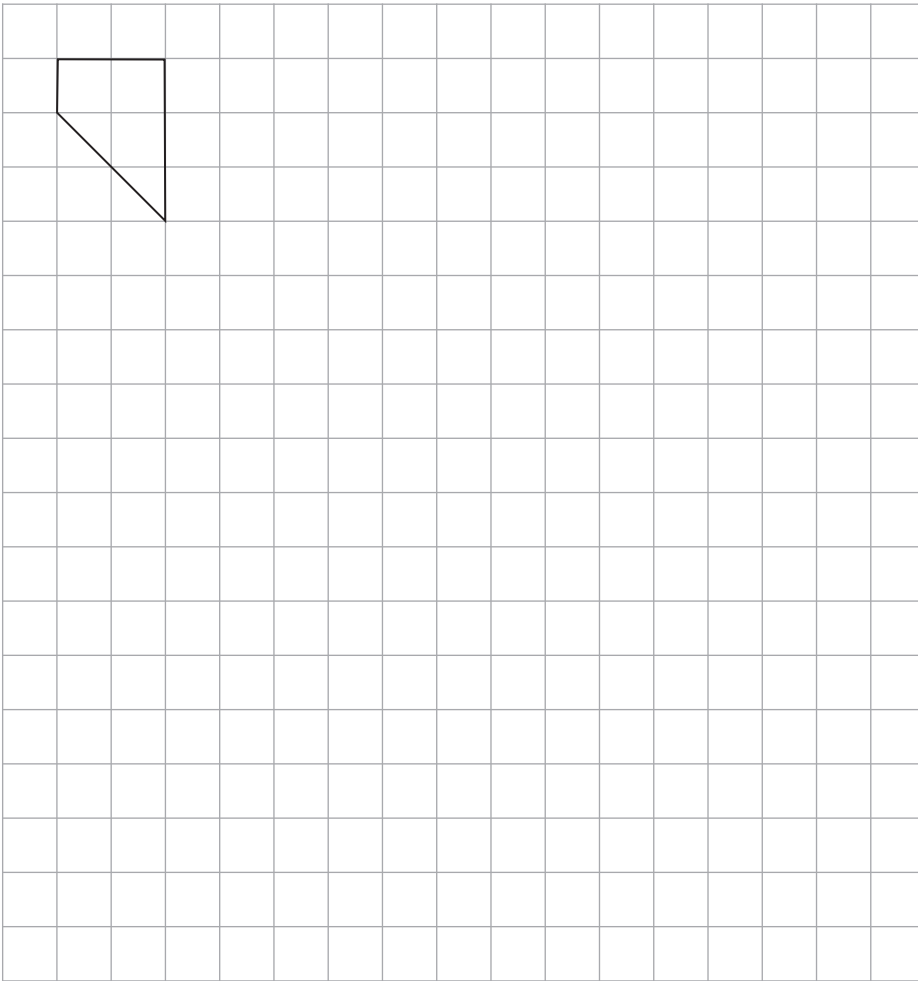

Turn over for the next question

Turn over ►



12

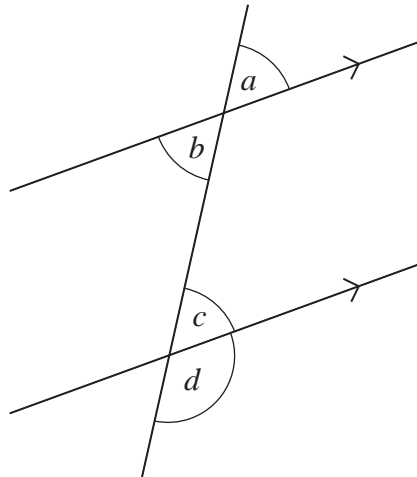

12 (a) Which angles are vertically opposite?  
Circle your answer.

[1 mark]

*a and b**a and c**b and c**b and d**c and d*

12 (b) Which angles are alternate?  
Circle your answer.

[1 mark]

*a and b**a and c**b and c**b and d**c and d*

12 (c) Which angles are corresponding?  
Circle your answer.

[1 mark]

*a and b**a and c**b and c**b and d**c and d*

13

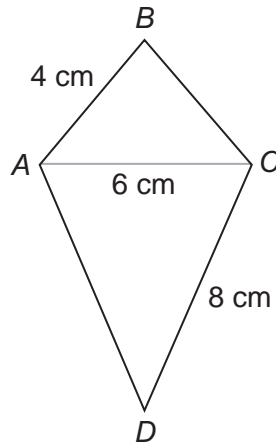
 $ABCD$  is a kite.

Not drawn accurately

Using a ruler and compasses, make an accurate construction of the kite.  
 $AC$  has been drawn for you.

**[3 marks]**

Turn over ►



14 (a)

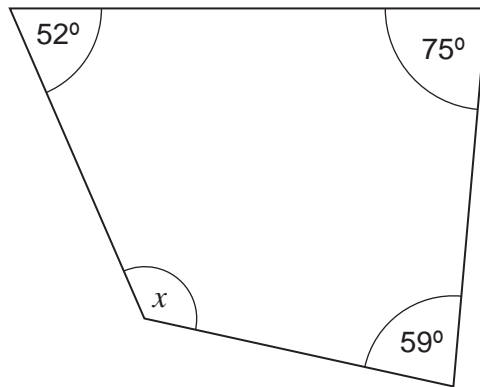

Not drawn accurately

Work out the value of  $x$ .**[2 marks]**

---

---

---

Answer \_\_\_\_\_ degrees



14 (b)  $AD$  is parallel to  $BC$ .

$$AE = DE$$

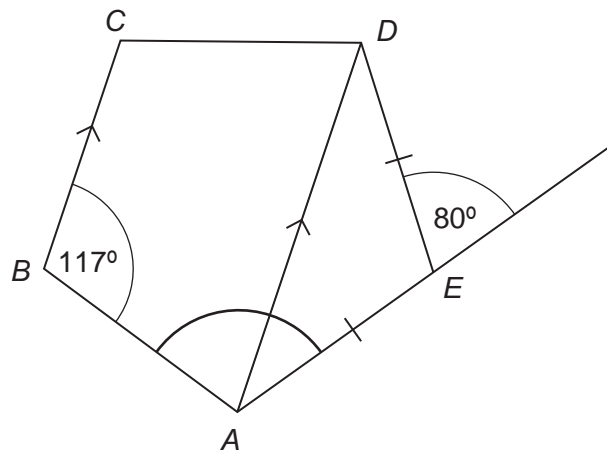

Not drawn accurately

Work out the size of angle  $BAE$ .

[3 marks]

---



---



---

Answer \_\_\_\_\_ degrees

Turn over for the next question



**\*15**

Oil is sold in two sizes.

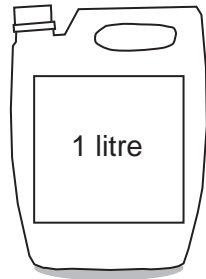

£8.75

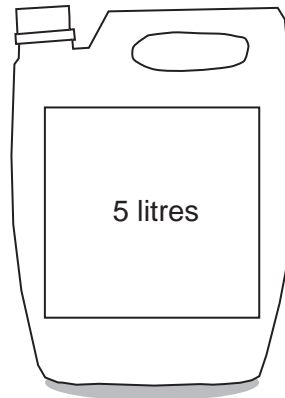

was £49.80

**now 15% off**

Which size is better value for money?  
You **must** show your working.

**[4 marks]**

---

---

---

---

---

---

---

---

---

---

Answer \_\_\_\_\_



**16** Jack drives 95 miles.

He drives at an average speed of 38 mph  
He starts his journey at 7 am

What time does he arrive?

**[3 marks]**

---

---

---

---

Answer \_\_\_\_\_

**Turn over for the next question**

|   |
|---|
| 7 |
|---|

**Turn over ►**



- 17 (a) The diagram shows a right-angled triangle.

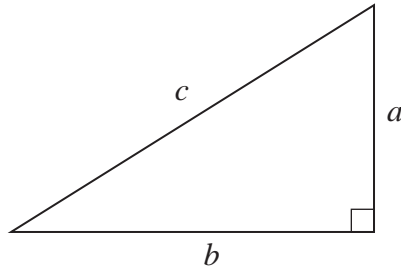

Circle the **two** correct formulae.

[2 marks]

$c = ab$

$c = a + b$

$c^2 = a^2 + b^2$

$c = \frac{1}{2} ab$

$c = \sqrt{a^2 + b^2}$

- 17 (b) Work out the length  $y$ .

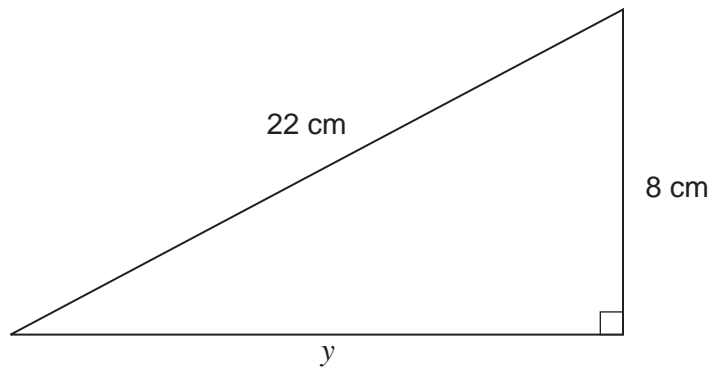

Not drawn  
accurately

Give your answer to 1 decimal place.

[4 marks]

---



---



---



---

Answer \_\_\_\_\_ cm





- \*18** Show that  $ABC$  is an equilateral triangle.

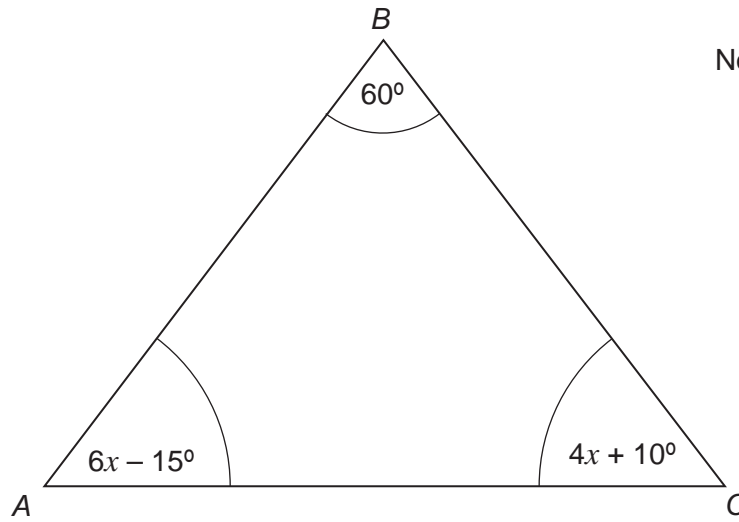

Not drawn accurately

[5 marks]

---

---

---

---

---

---

---

---

---

---



- 19 Two identical circles fit inside a rectangle as shown.

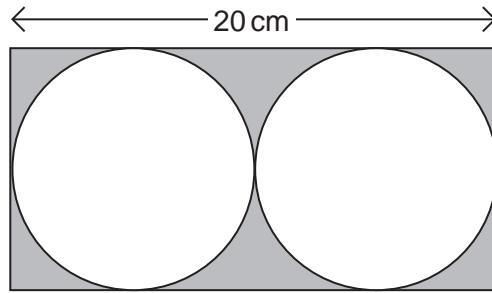

Not drawn  
accurately

The length of the rectangle is 20 cm

Work out the area of the shaded section.

[6 marks]

---

---

---

---

---

---

---

---

---

---

Answer \_\_\_\_\_ cm<sup>2</sup>

**END OF QUESTIONS**



**There are no questions printed on this page**

**DO NOT WRITE ON THIS PAGE  
ANSWER IN THE SPACES PROVIDED**



**There are no questions printed on this page**

**DO NOT WRITE ON THIS PAGE  
ANSWER IN THE SPACES PROVIDED**

**Copyright Information**

For confidentiality purposes, from the November 2015 examination series, acknowledgements of third party copyright material will be published in a separate booklet rather than including them on the examination paper or support materials. This booklet is published after each examination series and is available for free download from [www.aqa.org.uk](http://www.aqa.org.uk) after the live examination series.

Permission to reproduce all copyright material has been applied for. In some cases, efforts to contact copyright-holders may have been unsuccessful and AQA will be happy to rectify any omissions of acknowledgements. If you have any queries please contact the Copyright Team, AQA, Stag Hill House, Guildford, GU2 7XJ.

Copyright © 2016 AQA and its licensors. All rights reserved.

