

Please write clearly in block capitals.

Centre number

Candidate number

Surname \_\_\_\_\_

Forename(s) \_\_\_\_\_

Candidate signature \_\_\_\_\_

I declare this is my own work.

# GCSE PHYSICS

# H

Higher Tier Paper 1

Wednesday 20 May 2020 Afternoon Time allowed: 1 hour 45 minutes

## Materials

For this paper you must have:

- a ruler
- a scientific calculator
- the Physics Equations Sheet (enclosed).

## Instructions

- Use black ink or black ball-point pen. Pencil should only be used for drawing.
- Fill in the boxes at the top of this page.
- Answer **all** questions in the spaces provided.
- Do not write outside the box around each page or on blank pages.
- If you need extra space for your answer(s), use the lined pages at the end of this book. Write the question number against your answer(s).
- Do all rough work in this book. Cross through any work you do not want to be marked.
- In all calculations, show clearly how you work out your answer.

## Information

- The maximum mark for this paper is 100.
- The marks for questions are shown in brackets.
- You are expected to use a calculator where appropriate.
- You are reminded of the need for good English and clear presentation in your answers.

| For Examiner's Use |      |
|--------------------|------|
| Question           | Mark |
| 1                  |      |
| 2                  |      |
| 3                  |      |
| 4                  |      |
| 5                  |      |
| 6                  |      |
| 7                  |      |
| 8                  |      |
| 9                  |      |
| 10                 |      |
| <b>TOTAL</b>       |      |



**There are no questions printed on this page**

*Do not write  
outside the  
box*

**DO NOT WRITE ON THIS PAGE  
ANSWER IN THE SPACES PROVIDED**



Answer **all** questions in the spaces provided.

0 1

A student investigated how the current in a filament lamp varied with the potential difference across the filament lamp.

**Figure 1** shows part of the circuit used.

**Figure 1**

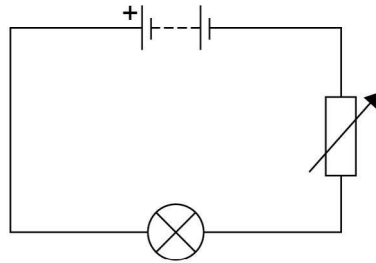

0 1 . 1

Complete **Figure 1** by adding an ammeter and a voltmeter.

Use the correct circuit symbols.

**[3 marks]**

**Question 1 continues on the next page**

**Turn over ►**



Figure 2 shows some of the results.

Figure 2

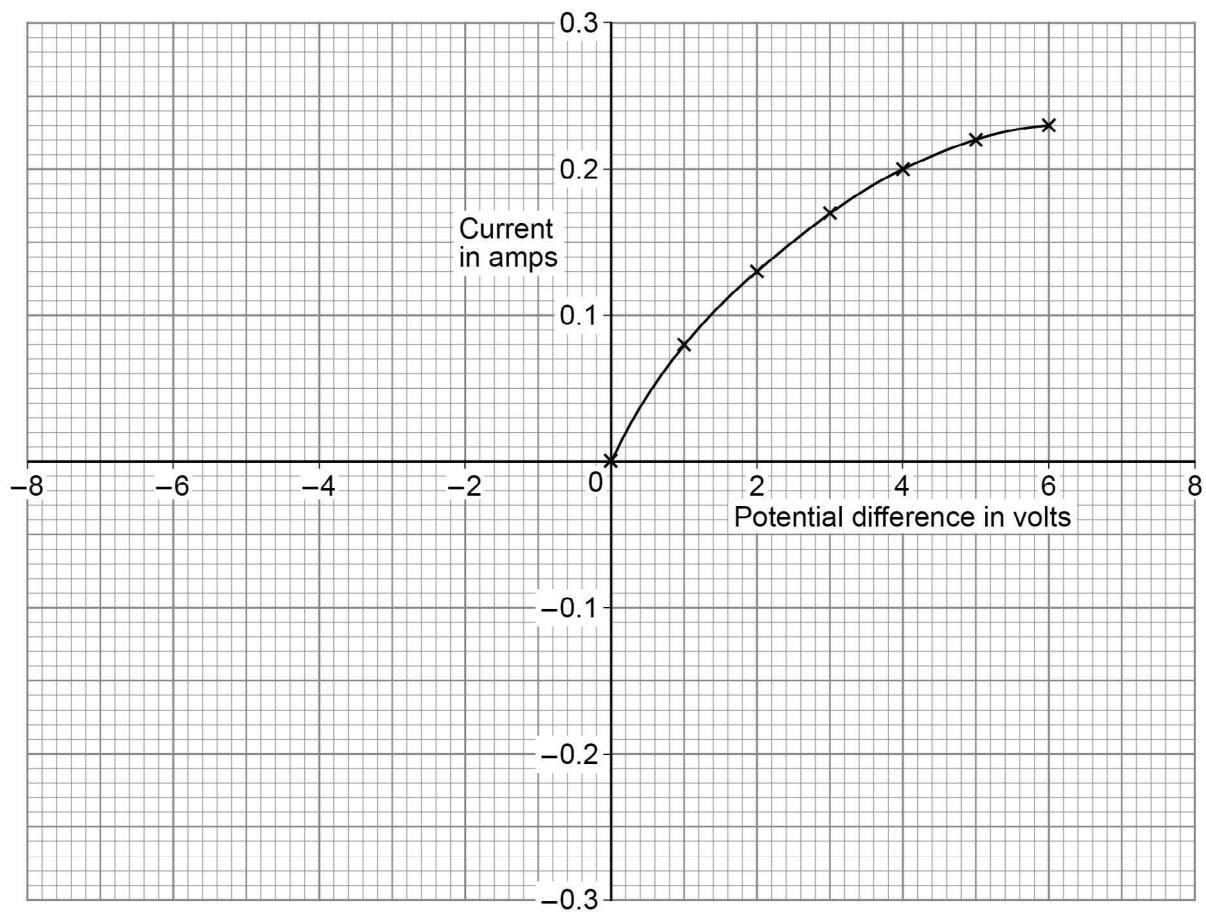

0 1 . 2

The student reversed the connections to the power supply and obtained negative values for the current and potential difference.

Draw a line on **Figure 2** to show the relationship between the negative values of current and potential difference.

[2 marks]



0 1 . 3

Write down the equation which links current ( $I$ ), potential difference ( $V$ ) and resistance ( $R$ ).

[1 mark]

---

0 1 . 4

Determine the resistance of the filament lamp when the potential difference across it is 1.0 V.

Use data from **Figure 2**.

[4 marks]

---



---



---



---

Resistance = \_\_\_\_\_  $\Omega$

0 1 . 5

A second student did the same investigation. The ammeter used had a zero error.

What is meant by a zero error?

[1 mark]

---



---

11

**Turn over for the next question**

**Turn over ►**



0 2

Figure 3 shows an LED torch.

Figure 3



0 2 . 1

The torch contains one LED, one switch and three cells.

Which diagram shows the correct circuit for the torch?

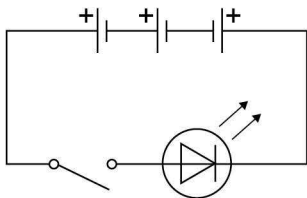
Tick (✓) **one** box.**[1 mark]**

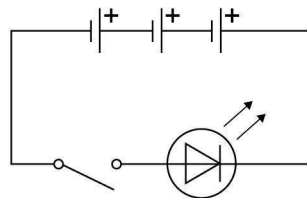

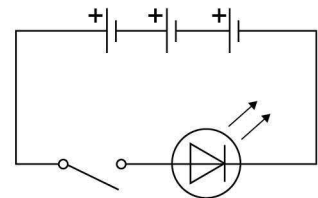



0 2 . 2

Write down the equation which links charge flow ( $Q$ ), current ( $I$ ) and time ( $t$ ).

[1 mark]

---

0 2 . 3

The torch worked for 14 400 seconds before the cells needed replacing.

The current in the LED was 50 mA.

Calculate the total charge flow through the cells.

[3 marks]

---

---

---

---

Total charge flow = \_\_\_\_\_ C

0 2 . 4

When replaced, the cells were put into the torch the wrong way around.

Explain why the torch did not work.

[2 marks]

---

---

---

---

---

---

Question 2 continues on the next page

Turn over ►



0 2 . 5

Write down the equation which links efficiency, total power input and useful power output.

**[1 mark]**

---

---

0 2 . 6

The total power input to the LED was 0.24 W.

The efficiency of the LED was 0.75

Calculate the useful power output of the LED.

**[3 marks]**

---

---

---

---

Useful power output = \_\_\_\_\_ W

**11**



**Turn over for the next question**

*Do not write  
outside the  
box*

**DO NOT WRITE ON THIS PAGE  
ANSWER IN THE SPACES PROVIDED**

**Turn over ►**



0 9

0 3

Figure 4 shows a hydroelectric power station.

Figure 4

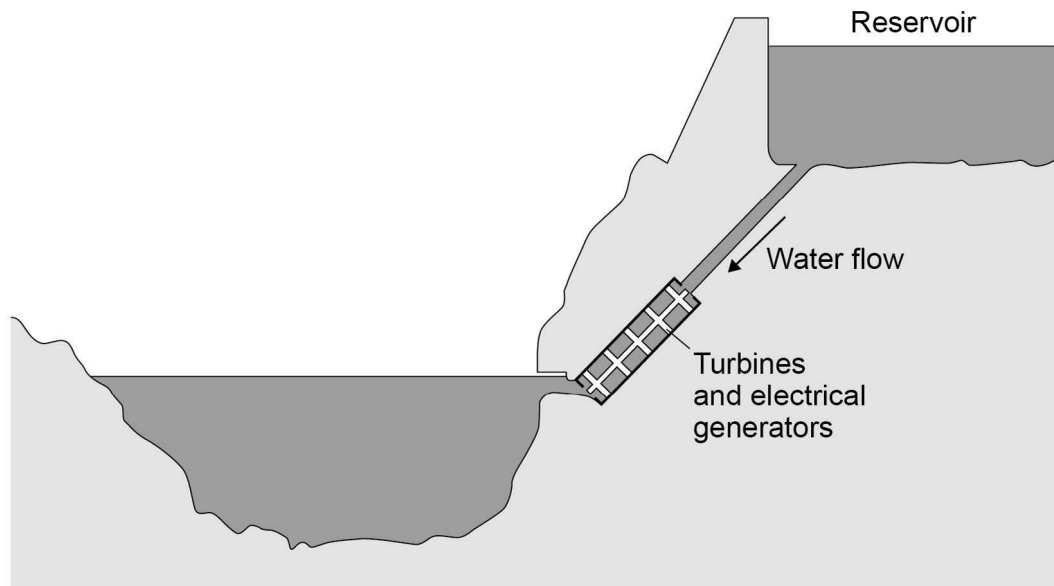

Electricity is generated when water from the reservoir flows through the turbines.

0 3 . 1

Write down the equation which links density ( $\rho$ ), mass ( $m$ ) and volume ( $V$ ).

[1 mark]

---

0 3 . 2

The reservoir stores 6 500 000 m<sup>3</sup> of water.

The density of the water is 998 kg/m<sup>3</sup>.

Calculate the mass of water in the reservoir.

Give your answer in standard form.

[4 marks]

---



---



---



---



---

Mass (in standard form) = \_\_\_\_\_ kg



0 3 . 3

Write down the equation which links energy transferred ( $E$ ), power ( $P$ ) and time ( $t$ ).**[1 mark]**

---

0 3 . 4

The electrical generators can provide  $1.5 \times 10^9$  W of power for a maximum of 5 hours.

Calculate the maximum energy that can be transferred by the electrical generators.

**[3 marks]**

---

---

---

---

---

Energy transferred = \_\_\_\_\_ J

**Question 3 continues on the next page****Turn over ►**

0 3 . 5

**Figure 5** shows how the UK demand for electricity increases and decreases during one day.

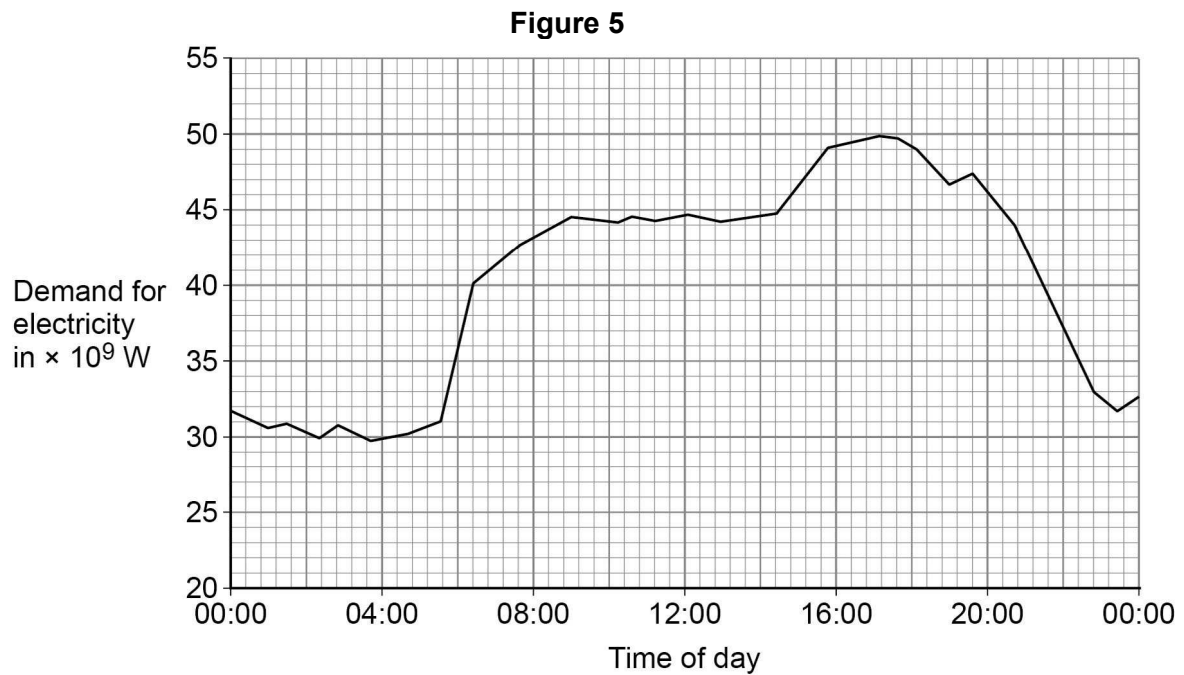

The hydroelectric power station in **Figure 4** can provide  $1.5 \times 10^9$  W of power for a maximum of 5 hours.

Give **two** reasons why this hydroelectric power station is not able to meet the increase in demand shown between 04:00 and 16:00 in **Figure 5**.

[2 marks]

1

---



---

2

---



---

11



**Turn over for the next question**

*Do not write  
outside the  
box*

**DO NOT WRITE ON THIS PAGE  
ANSWER IN THE SPACES PROVIDED**

**Turn over ►**



0 4

**Figure 6** shows how much electricity was generated using coal-fired and gas-fired power stations in January for 5 years in the UK.

**Figure 6**

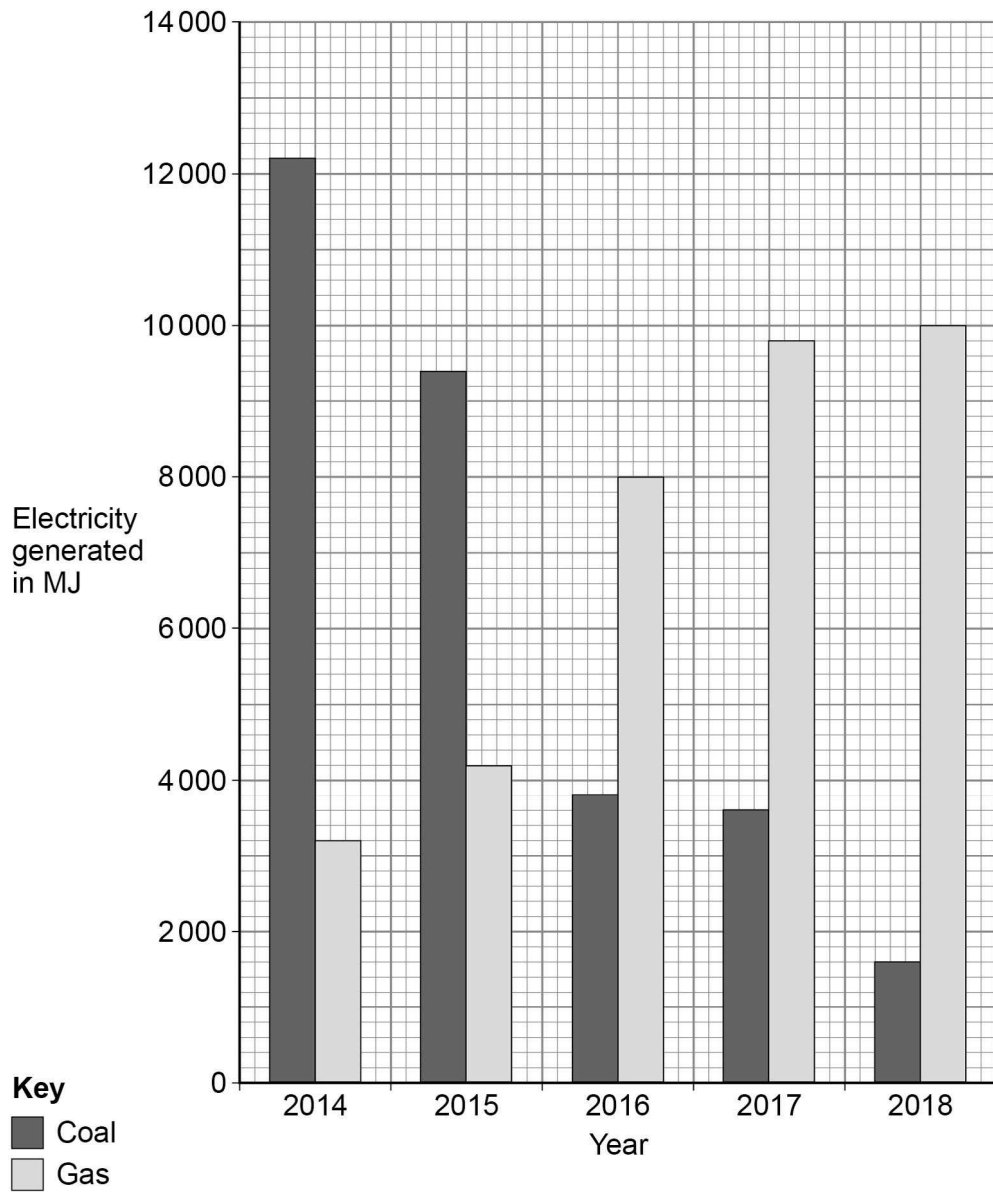

0 4 . 1

Determine the percentage increase in electricity generated using gas-fired power stations from 2014 to 2018.

**[2 marks]**

---



---



---

Percentage increase = \_\_\_\_\_ %



|   |   |   |   |
|---|---|---|---|
| 0 | 4 | . | 2 |
|---|---|---|---|

Give **two** environmental advantages of using a gas-fired power station to generate electricity compared with using a coal-fired power station.

**[2 marks]**

1 \_\_\_\_\_

\_\_\_\_\_

2 \_\_\_\_\_

\_\_\_\_\_

**Question 4 continues on the next page**

**Turn over ►**



The mean surface temperature of the sea changes throughout the year.

A change in the mean surface temperature from year to year indicates climate change.

**Figure 7** shows how the mean surface temperature changed between 1988 and 2016.

**Figure 7**

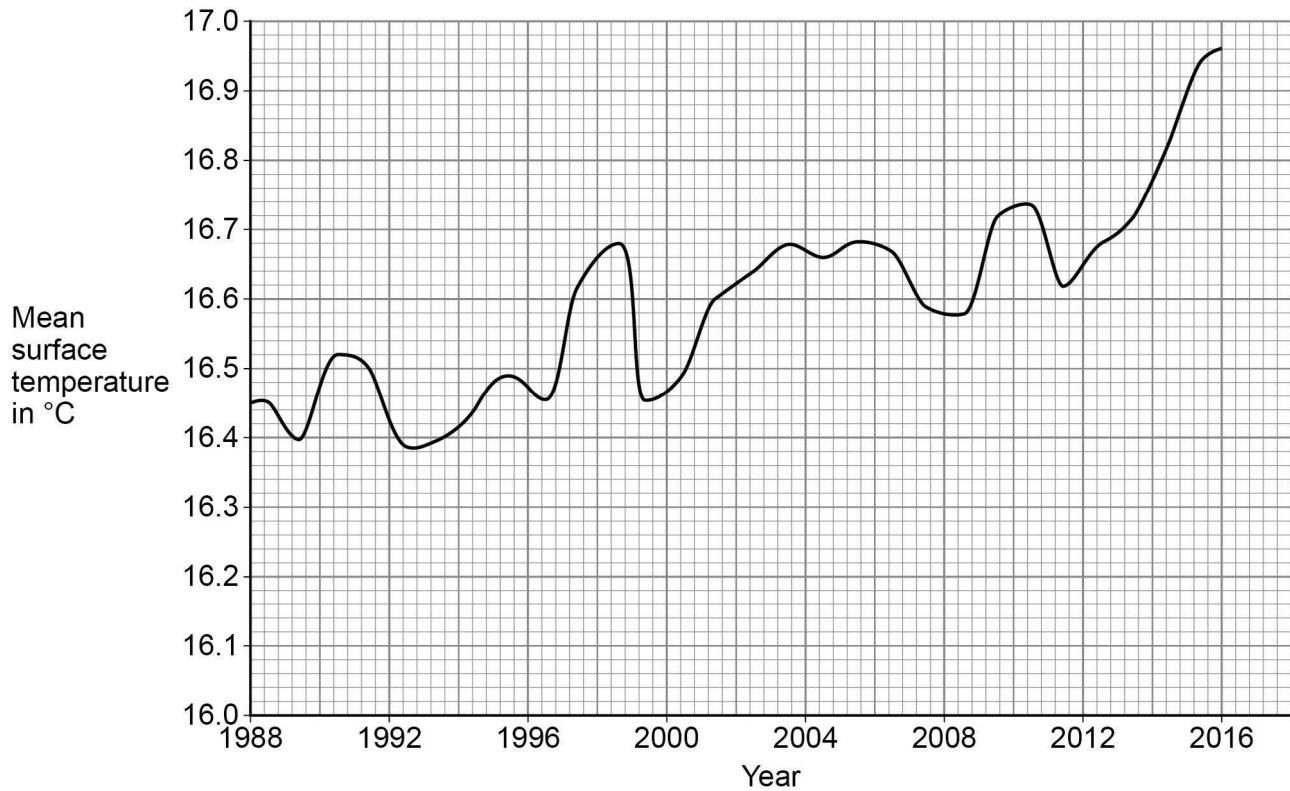

0 4 . 3

A student does not believe that climate change is occurring.

Explain how the data in **Figure 7** suggests the student is wrong.

**[2 marks]**

---



---



---



---



---





0 4 . 4

A thermistor can be used to measure temperature.

**Figure 8** shows how the resistance of four different thermistors A, B, C and D, varies with temperature.

**Figure 8**

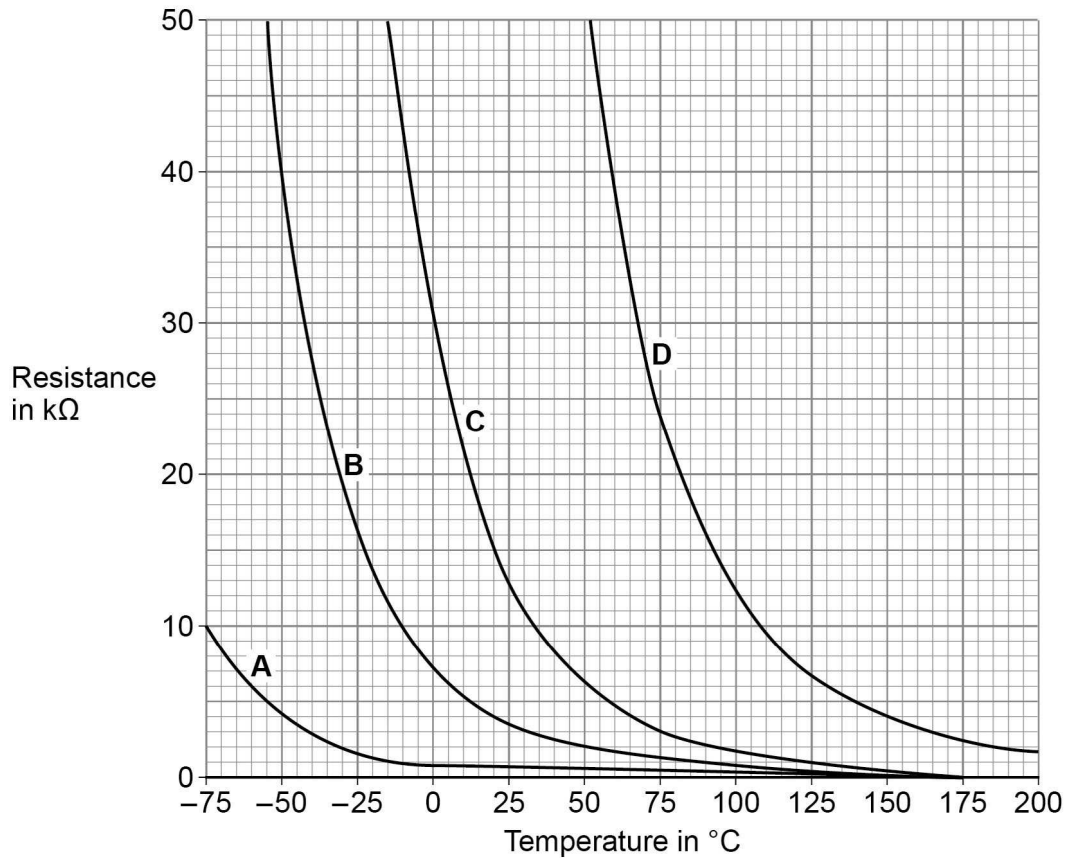

Which of the four thermistors would be the most suitable to measure the surface temperature of the sea?

Tick (✓) **one** box.

Explain your answer.

**[3 marks]**

|                          |                          |                          |                          |
|--------------------------|--------------------------|--------------------------|--------------------------|
| <b>A</b>                 | <b>B</b>                 | <b>C</b>                 | <b>D</b>                 |
| <input type="checkbox"/> | <input type="checkbox"/> | <input type="checkbox"/> | <input type="checkbox"/> |

---



---



---



---

9

Turn over ►



**0 5**

Radioactive waste from nuclear power stations is a man-made source of background radiation.

**0 5 . 1**

Give **one** other man-made source of background radiation.

**[1 mark]**

---

Nuclear power stations use the energy released by nuclear fission to generate electricity.

**0 5 . 2**

Give the name of **one** nuclear fuel.

**[1 mark]**

---

**0 5 . 3**

Nuclear fission releases energy.

Describe the process of nuclear fission inside a nuclear reactor.

**[4 marks]**

---

---

---

---

---

---

---

---



**0 5 . 4** A new type of power station is being developed that will generate electricity using nuclear fusion.

Explain how the process of nuclear fusion leads to the release of energy.

**[2 marks]**

---

---

---

---

**0 5 . 5** Nuclear fusion power stations will produce radioactive waste. This waste will have a much shorter half-life than the radioactive waste from a nuclear fission power station.

Explain the advantage of the radioactive waste having a shorter half-life.

**[2 marks]**

---

---

---

---

**10**

**Turn over for the next question**

**Turn over ►**



0 6

**Figure 9** shows a theme park ride called AquaShute.

Riders of the AquaShute sit on a sled and move down a slide.

**Figure 9**

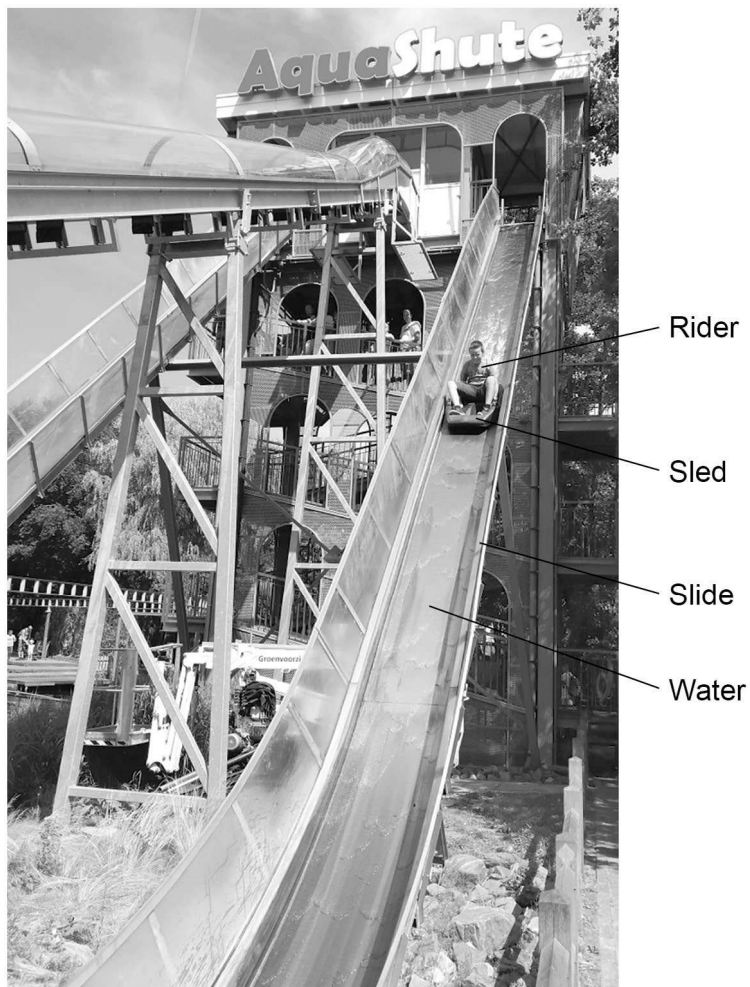

0 6 . 1

A light gate and data logger can be used to determine the speed of each rider and sled.

What two measurements are needed to determine the speed of a rider and sled?

**[2 marks]**

Tick (✓) **two** boxes.

Gravitational field strength

Length of sled

Mass of rider and sled

Temperature of surroundings

Time for sled to pass light gate



**0 6 . 2** The decrease in gravitational potential energy of one rider on the slide was 8.33 kJ.

The rider moved through a vertical height of 17.0 m.

gravitational field strength = 9.8 N/kg

Calculate the mass of the rider.

**[4 marks]**

---

---

---

---

Mass of rider = \_\_\_\_\_ kg

**0 6 . 3** At the bottom of the slide, all riders and their sleds have approximately the same speed.

Explain why.

**[4 marks]**

---

---

---

---

---

---

---

---

---

---

10

**Turn over for the next question**

**Turn over ►**



0 7

An electric kettle was switched on.

Figure 10 shows how the temperature of the water inside the kettle changed.

Figure 10

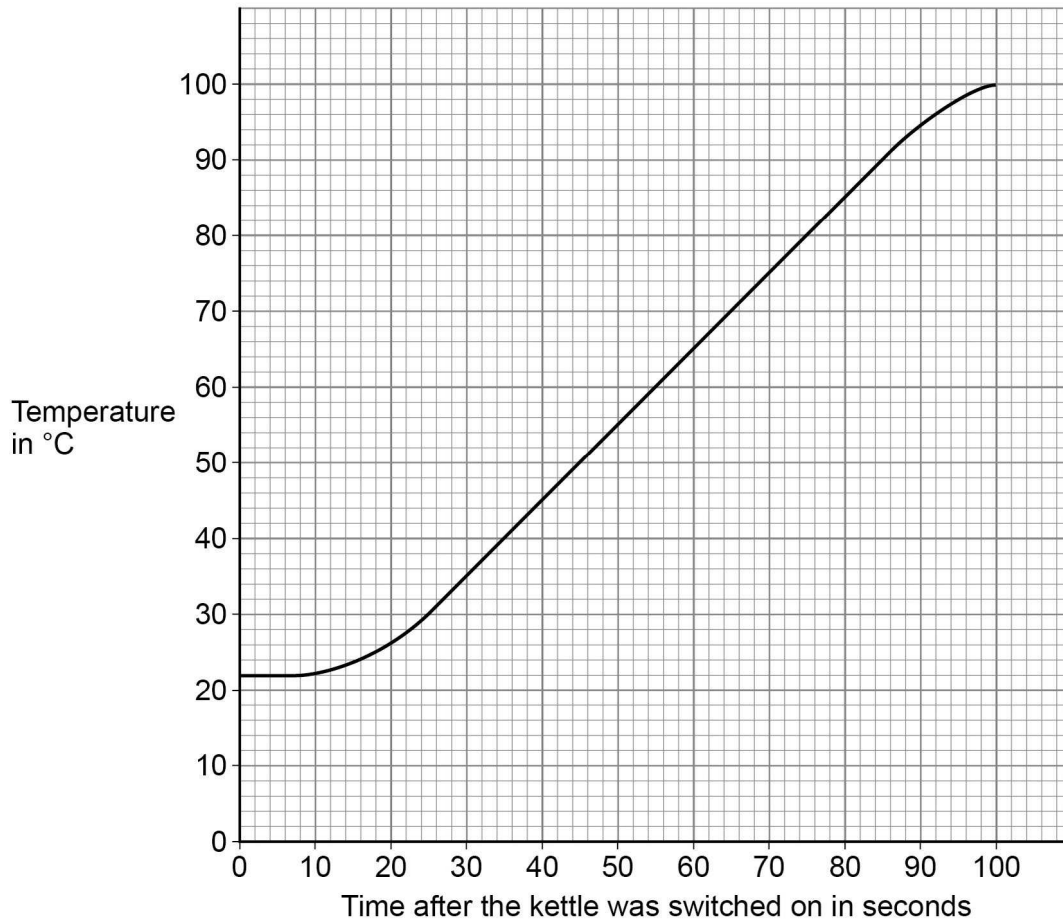

0 7 . 1

When the kettle was switched on the temperature of the water did **not** immediately start to increase.

Suggest **one** reason why.

[1 mark]

---



---



---



**0 7 . 2** The energy transferred to the water in 100 seconds was 155 000 J.

specific heat capacity of water = 4200 J/kg °C

Determine the mass of water in the kettle.

Use **Figure 10**.

Give your answer to 2 significant figures.

**[5 marks]**

---

---

---

---

---

---

---

---

---

---

Mass of water (2 significant figures) = \_\_\_\_\_ kg

**0 7 . 3** The straight section of the line in **Figure 10** can be used to calculate the useful power output of the kettle.

Explain how.

**[3 marks]**

---

---

---

---

---

---

---

---

---

---



0 8

A student investigated how the total resistance of identical resistors connected in parallel varied with the number of resistors.

The student used an ohmmeter to measure the total resistance of the resistors.

**Figure 11** shows the student's circuit with 3 resistors.

**Figure 11**

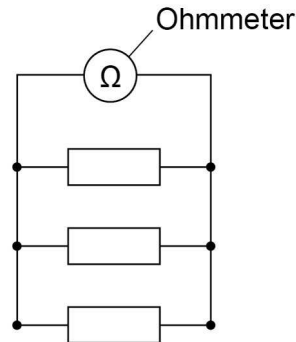

The student repeated each reading of resistance three times.

**Table 1** shows some of the results for 3 resistors in parallel.

**Table 1**

| Number of resistors | Total resistance in ohms |           |           |      |
|---------------------|--------------------------|-----------|-----------|------|
|                     | Reading 1                | Reading 2 | Reading 3 | Mean |
| 3                   | 15.8                     | 15.3      | <b>X</b>  | 15.7 |

0 8

. 1

Calculate value **X** in **Table 1**.

**[2 marks]**

---



---



---

X = \_\_\_\_\_  $\Omega$





|   |   |   |   |
|---|---|---|---|
| 0 | 8 | . | 2 |
|---|---|---|---|

The student thought that taking a fourth reading would improve the precision of the results.

The fourth reading was  $16.2 \Omega$ .

Explain why the student was wrong.

**[2 marks]**

---

---

---

---

**Question 8 continues on the next page**

**Turn over ►**



Figure 12 shows the results from the investigation.

Figure 12

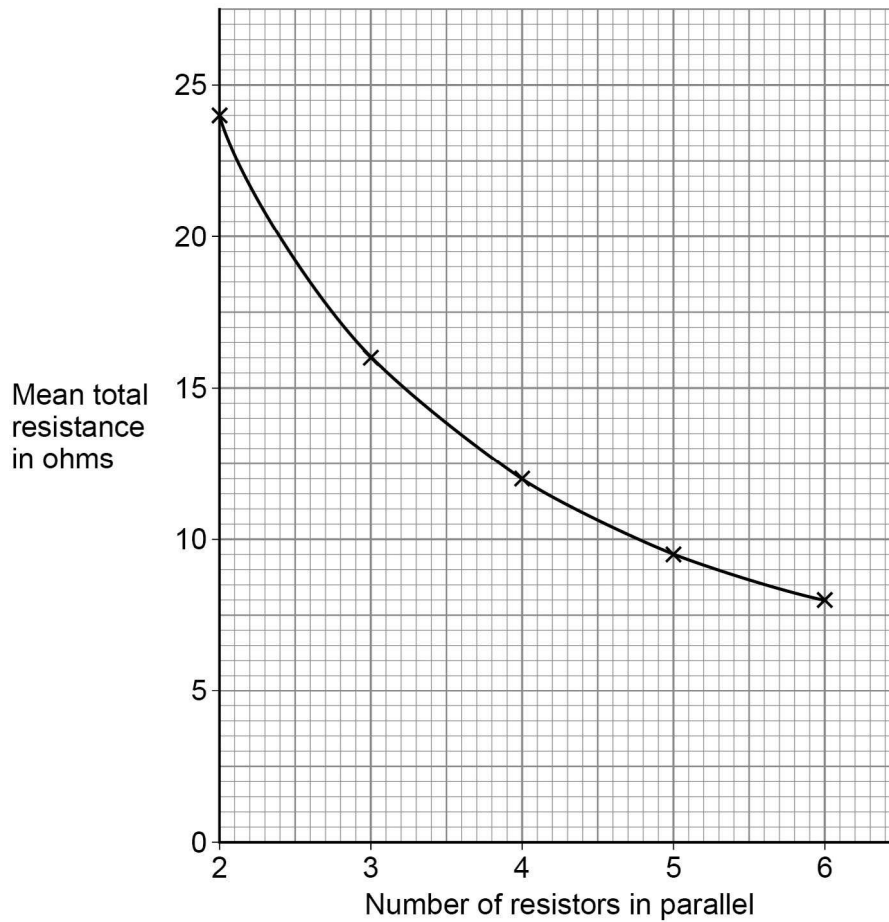

0 8 . 3

The student concluded that the number of resistors in parallel was inversely proportional to the mean total resistance.

Explain why the student was correct.

Use data from **Figure 12** in your answer.

[3 marks]

---



---



---



---



---



---



0 8 . 4

Explain why adding resistors in parallel decreases the total resistance.

**[2 marks]**

---

---

---

---

---

**9****Turn over for the next question****Turn over ►**

0 9

Figure 13 shows part of a mains electricity lighting circuit in a house.

Figure 13

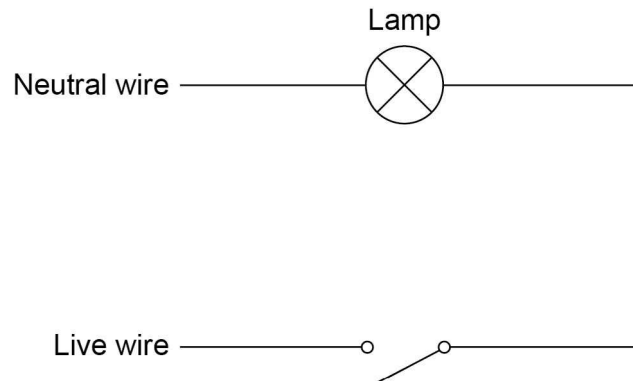

0 9 . 1

A fault in the switch caused a householder to receive a mild electric shock before a safety device switched the circuit off.

The mean power transfer to the person was 5.75 W.

The potential difference across the person was 230 V.

Calculate the resistance of the person.

[5 marks]

---



---



---



---



---



---



---



---



---



---

Resistance = \_\_\_\_\_  $\Omega$



**0 9 . 2** An electrician replaced the switch.

The electrician would have received an electric shock unless the circuit was disconnected from the mains supply.

Explain why.

**[3 marks]**

---

---

---

---

---

---

---

**Question 9 continues on the next page**

**Turn over ►**



09.3

The current from an electric shock causes a person's muscles to contract. The person cannot let go of the electrical circuit if the current is too high.

**Figure 14** shows how the maximum current at which a person can let go depends on the frequency of the electricity supply.

**Figure 14**

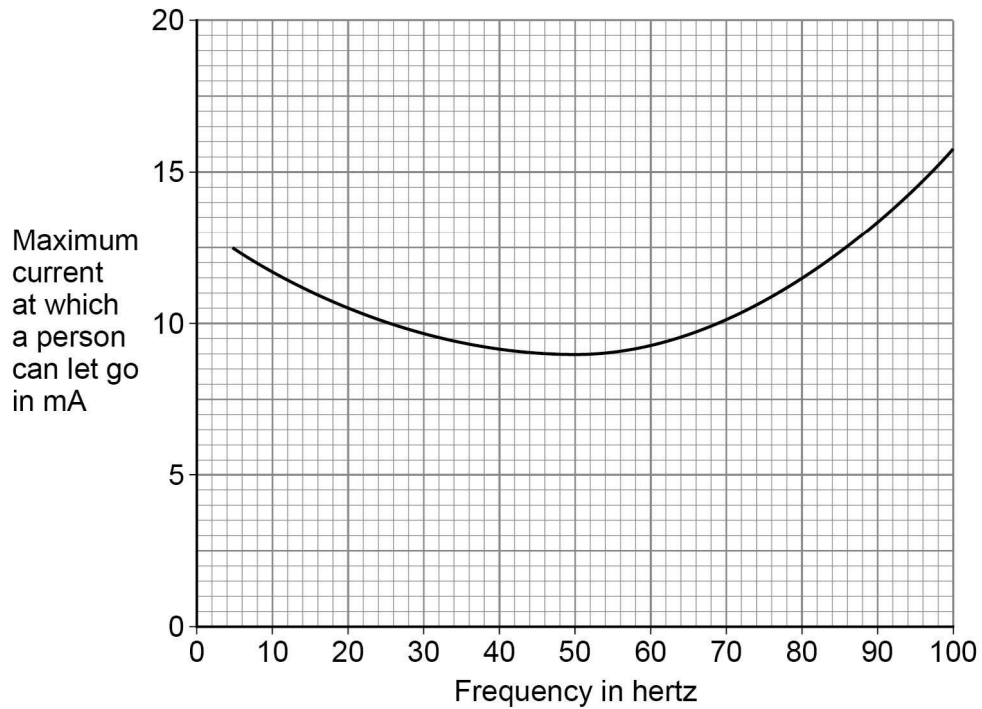

The UK mains frequency is 50 Hz.

Explain why it would be safer if the UK mains frequency was **not** 50 Hz.

**[2 marks]**

---



---



---



---



---



---



---

10



**Turn over for the next question**

*Do not write  
outside the  
box*

**DO NOT WRITE ON THIS PAGE  
ANSWER IN THE SPACES PROVIDED**

**Turn over ►**



1 0

Figure 15 shows a balloon filled with helium gas.

Figure 15



1 0 . 1

Which statements describe the movement of the gas particles in the balloon?

[2 marks]

Tick (✓) **two** boxes.

The particles all move in a predictable way.

The particles move at the same speed.

The particles move in circular paths.

The particles move in random directions.

The particles move with a range of speeds.

The particles vibrate about fixed positions.





**1 0 . 2** The pressure of the helium in the balloon is 100 000 Pa.

The volume of the balloon is 0.030 m<sup>3</sup>.

The balloon is compressed at a constant temperature causing the volume to decrease to 0.025 m<sup>3</sup>.

No helium leaves the balloon.

Calculate the new pressure in the balloon.

**[4 marks]**

---

---

---

---

---

---

---

---

New pressure = \_\_\_\_\_ Pa

**1 0 . 3** The temperature of the helium in the balloon was increased.

The mass and volume of helium in the balloon remained constant.

Explain why the pressure exerted by the helium inside the balloon would increase.

**[4 marks]**

---

---

---

---

---

---

---

---

10

**END OF QUESTIONS**



**There are no questions printed on this page**

*Do not write  
outside the  
box*

**DO NOT WRITE ON THIS PAGE  
ANSWER IN THE SPACES PROVIDED**





Do not write outside the box

| Question number | <b>Additional page, if required.</b><br><b>Write the question numbers in the left-hand margin.</b>  |
|-----------------|---|
|                 | <p>.....</p> <p>.....</p> <p>.....</p> <p>.....</p> <p>.....</p> <p>.....</p> <p>.....</p> <p>.....</p> <p>.....</p> <p>.....</p> <p>.....</p> <p>.....</p> <p>.....</p> <p>.....</p> <p>.....</p> <p>.....</p> <p>.....</p> <p>.....</p> <p>.....</p> <p>.....</p> <p>.....</p> <p>.....</p> <p>.....</p> <p>.....</p> <p>.....</p>  |
|                 | <p><b>Copyright information</b></p> <p>For confidentiality purposes, all acknowledgements of third-party copyright material are published in a separate booklet. This booklet is published after each live examination series and is available for free download from <a href="http://www.aqa.org.uk">www.aqa.org.uk</a>.</p> <p>Permission to reproduce all copyright material has been applied for. In some cases, efforts to contact copyright-holders may have been unsuccessful and AQA will be happy to rectify any omissions of acknowledgements. If you have any queries please contact the Copyright Team.</p> <p>Copyright © 2020 AQA and its licensors. All rights reserved.</p> |

