

Centre Number						Candidate Number				
Surname										
Other Names										
Candidate Signature										

For Examiner's Use	
Examiner's Initials	
Question	Mark
1	
2	
3	
4	
5	
6	
7	
8	
9	
TOTAL	



General Certificate of Secondary Education
Foundation Tier
January 2013

Additional Science
Unit Physics P2

PH2FP
F

Physics
Unit Physics P2

Friday 25 January 2013 1.30 pm to 2.30 pm

For this paper you must have:

- a ruler
- a calculator
- the Physics Equations Sheet (enclosed).

Time allowed

- 1 hour

Instructions

- Use black ink or black ball-point pen.
- Fill in the boxes at the top of this page.
- Answer **all** questions.
- You must answer the questions in the spaces provided. Do not write outside the box around each page or on blank pages.
- Do all rough work in this book. Cross through any work you do not want to be marked.

Information

- The marks for questions are shown in brackets.
- The maximum mark for this paper is 60.
- You are expected to use a calculator where appropriate.
- Question 9(c) should be answered in continuous prose. In this question you will be marked on your ability to:
 - use good English
 - organise information clearly
 - use specialist vocabulary where appropriate.

Advice

- In all calculations, show clearly how you work out your answer.



J A N 1 3 P H 2 F P O 1

G/K89954 6/6/6

PH2FP

Answer **all** questions in the spaces provided.

- 1 (a)** The diagram shows two forces acting on an object.

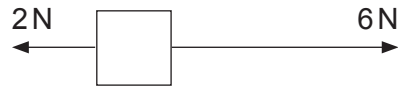

What is the resultant force acting on the object?

Tick (✓) **one** box.

8 N to the right

8 N to the left

4 N to the right

4 N to the left

(1 mark)

- 1 (b)** BASE jumpers jump from very high buildings and mountains for sport.

The diagram shows the forces acting on a BASE jumper in flight.
The BASE jumper is wearing a wingsuit.

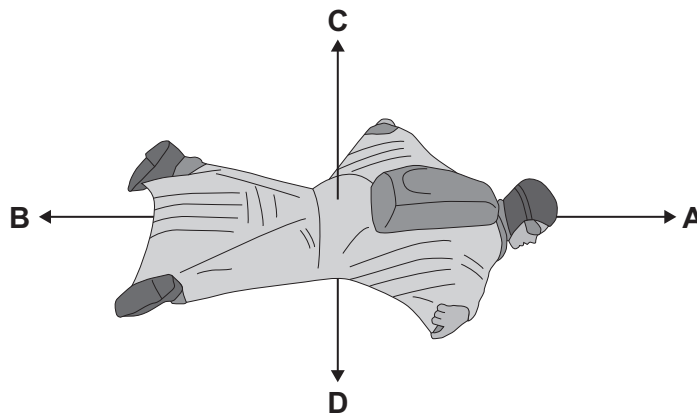

1 (b) (i) Draw a ring around the correct answer in the box to complete each sentence.

The BASE jumper accelerates forwards when force **A** is

smaller than

equal to

force **B**.

bigger than

The BASE jumper falls with a constant speed when force **C** is

smaller than

equal to

force **D**.

bigger than

(2 marks)

1 (b) (ii) To land safely the BASE jumper opens a parachute.

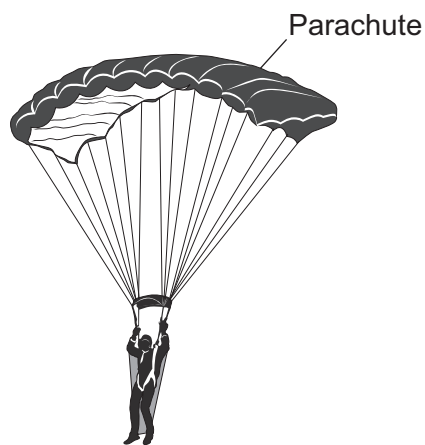

What effect does opening the parachute have on the speed of the falling BASE jumper?

.....

Give a reason for your answer.

.....

.....

(2 marks)

5

Turn over ►



2 (a) Sources of background radiation are either natural or man-made.

Which **two** of the sources listed in the box are *natural* sources of background radiation?

Draw a ring around each of your answers.

cosmic rays	nuclear accidents	X-rays	radon gas
-------------	-------------------	--------	-----------

(2 marks)

2 (b) A teacher used a Geiger-Müller (GM) tube and counter to measure the background radiation in her laboratory. The teacher reset the counter to zero, waited one minute and then took the count reading. The teacher repeated this two more times.

The three readings taken by the teacher are given in the table.

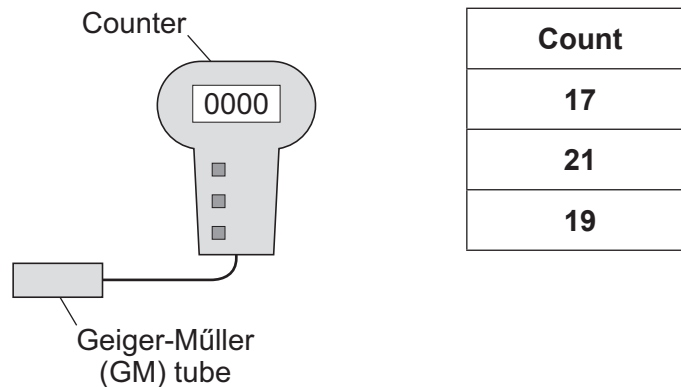

2 (b) (i) The three readings are different.

What is the most likely reason for this?

Tick (✓) **one** box.

The teacher did not reset the counter to zero.

Radioactive decay is a random process.

The temperature in the laboratory changed.

(1 mark)

2 (b) (ii) Calculate the mean (average) value of the three readings given in the table.

.....

Mean (average) value = counts
(1 mark)



2 (b) (iii) The diagram shows how the teacher used the GM tube and counter to measure the radiation emitted from a radioactive source.

The counter was reset to zero. The count after one minute was 159.

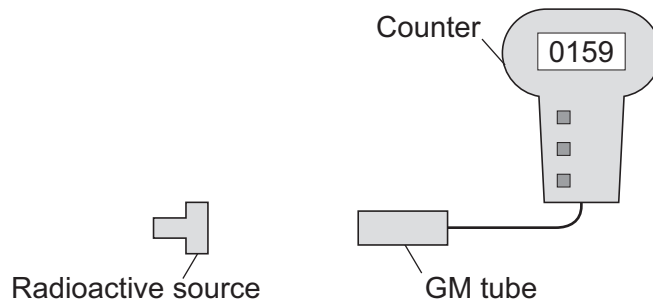

Calculate how many counts were due to the radiation from the radioactive source.

.....

Counts due to the radiation from the radioactive source =
 (1 mark)

2 (b) (iv) The teacher then put a powerful magnet between the radioactive source and the GM tube.

The counter was reset to zero. The number on the counter shows the count after one minute.

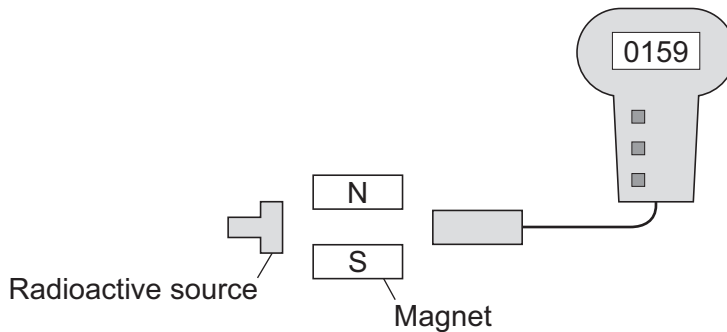

What type of radiation was being emitted from the radioactive source?

Draw a ring around your answer.

alpha beta gamma

Explain the reason for your answer.

.....

(3 marks)

Turn over ►



- 2 (c)** At the end of the lesson the teacher put the radioactive source back inside its storage box.

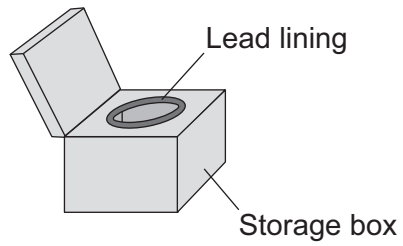

Why is the inside of the box lined with lead?

.....

.....

(1 mark)

- 2 (d)** Which **one** of the following questions **cannot** be answered by scientific study?

Tick (✓) **one** box.

Where does background radiation come from?

What is meant by the half-life of a radioactive source?

Should radioactive waste be dumped in the oceans?

(1 mark)

10



Turn over for the next question

**DO NOT WRITE ON THIS PAGE
ANSWER IN THE SPACES PROVIDED**

Turn over ►



0 7

- 3 (a)** Electrical circuits often contain resistors.
The diagram shows **two** resistors joined in series.

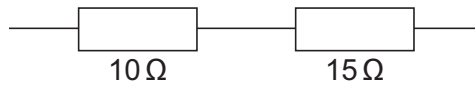

Calculate the total resistance of the **two** resistors.

.....

Total resistance = Ω
(1 mark)

- 3 (b)** A circuit was set up as shown in the diagram. The three resistors are identical.

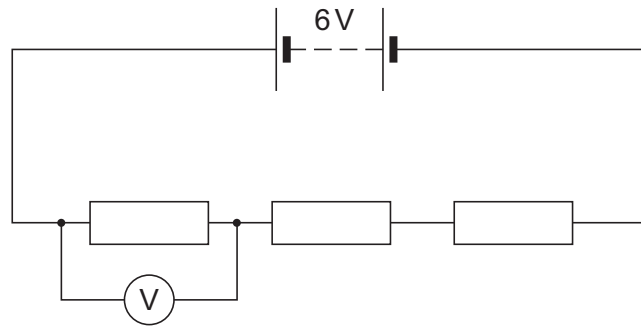

- 3 (b) (i)** Calculate the reading on the voltmeter.

.....

.....

Reading on voltmeter = V
(2 marks)



3 (b) (ii) The same circuit has now been set up with two ammeters.

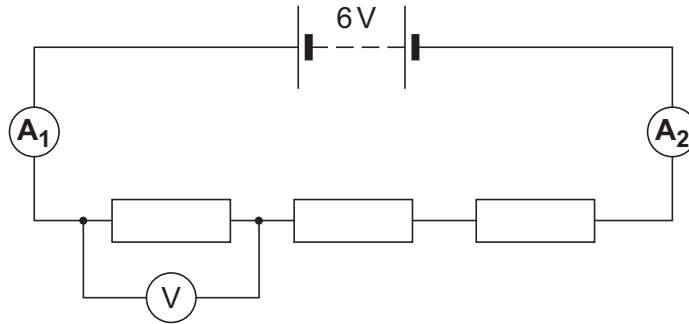

Draw a ring around the correct answer in the box to complete the sentence.

The reading on ammeter A_2 will be

smaller than
equal to
greater than

the reading on ammeter A_1 .

(1 mark)

4

Turn over for the next question

Turn over ►



4 (a) The diagram shows the information plate on an electric kettle. The kettle is plugged into the a.c. mains electricity supply.



Use the information from the plate to answer the following questions.

4 (a) (i) What is the frequency of the a.c. mains electricity supply?

.....
(1 mark)

4 (a) (ii) What is the power of the electric kettle?

.....
(1 mark)

4 (b) To boil the water in the kettle, 2400 coulombs of charge pass through the heating element in 200 seconds.

Calculate the current flowing through the heating element and give the unit.

Use the correct equation from the Physics Equations Sheet.

Choose the unit from the list below.

amps

volts

watts

.....
.....
.....

Current =
(3 marks)



- 4 (c) The amount of charge passing through the heating element of an electric kettle depends on the time the kettle is switched on.

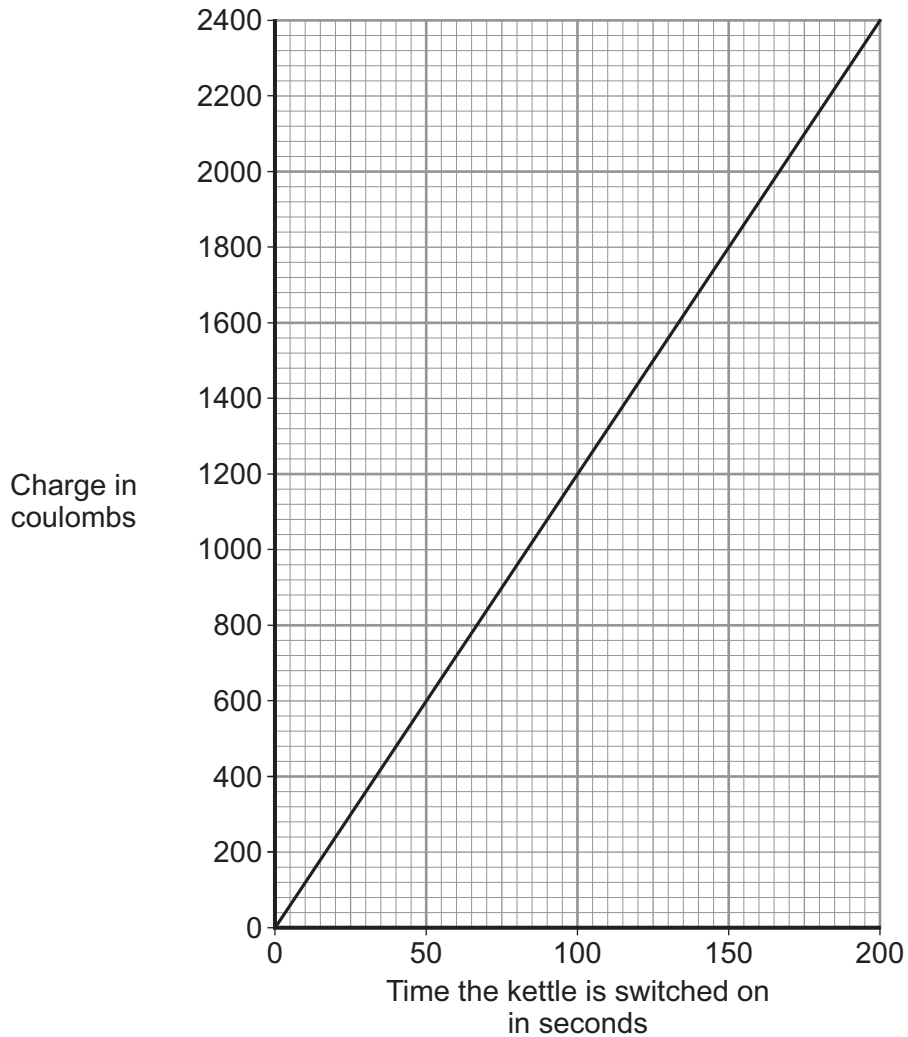

What pattern links the amount of charge passing through the heating element and the time the kettle is switched on?

.....

.....

(2 marks)

7

Turn over ►



5 (a) A student uses some everyday items to investigate static electricity.

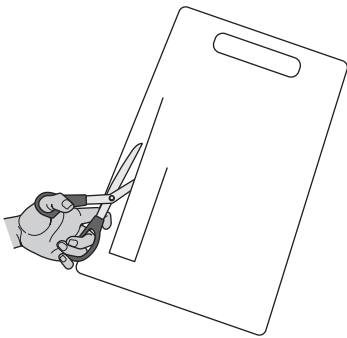

1 A strip of plastic is cut from a plastic carrier bag

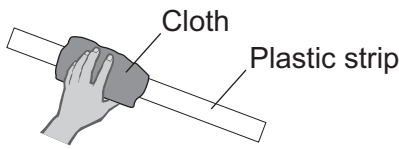

2 The plastic strip is rubbed with a cloth

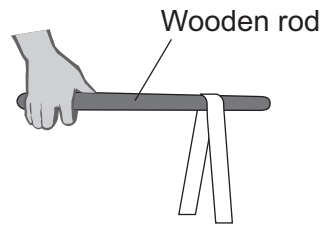

3 The plastic strip is hung over a wooden rod

5 (a) (i) Draw a ring around the correct answer in the box to complete each sentence.

Rubbing the plastic strip with a cloth causes the strip to become negatively charged.

This happens because

electrons
neutrons
protons

 move from the cloth onto the plastic strip.

The cloth is left with

a negative
a positive
zero

 charge.

(2 marks)

5 (a) (ii) When the plastic strip is hung over the wooden rod, the two halves of the strip move equally away from each other.

What **two** conclusions should the student make about the forces acting on the two halves of the plastic strip?

- 1
-
- 2
-

(2 marks)



5 (b) Electrical charges move more easily through some materials than through other materials.

Through which **one** of the following materials would an electrical charge move most easily?

Draw a ring around your answer.

aluminium

glass

rubber

(1 mark)

5

Turn over for the next question

Turn over ►



6 Some students designed and built an electric-powered go-kart.
The go-kart is shown below.

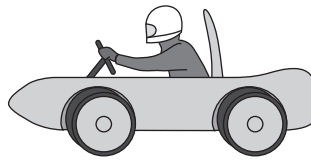

6 (a) Suggest **two** changes that could be made to the design of the go-kart to increase its top speed.

1

.....

2

.....

(2 marks)

6 (b) A go-kart with a new design is entered into a race.
The velocity-time graph for the go-kart, during the first 40 seconds of the race, is shown below.

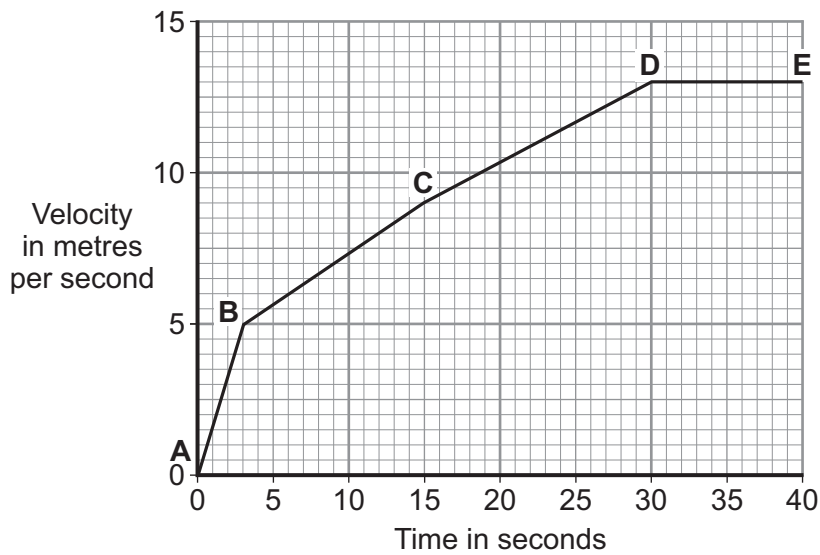

6 (b) (i) Between which **two** points did the go-kart have the greatest acceleration?

Tick (✓) **one** box.

A–B

B–C

C–D

Give a reason for your answer.

.....
.....

(2 marks)

6 (b) (ii) The go-kart travels at a speed of 13 m/s between points **D** and **E**.
The total mass of the go-kart and driver is 140 kg.

Calculate the momentum of the go-kart and driver between points **D** and **E**.

Use the correct equation from the Physics Equations Sheet.

.....
.....

Momentum = kg m/s
(2 marks)

6

Turn over for the next question

Turn over ▶



7 The diagram shows the structure of an atom.

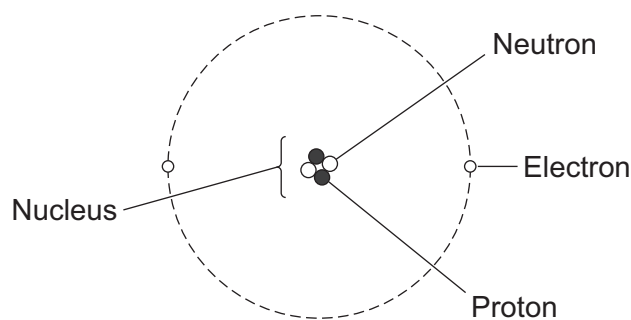

Not drawn to scale

7 (a) In 1931 scientists thought that atoms contained **only** protons and electrons.

Suggest what happened in 1932 to change the idea that atoms contained only protons and electrons.

.....

.....

(1 mark)

7 (b) The table gives information about the particles in an atom.

Complete the table by adding the names of the particles.

Particle	Relative Mass	Relative Charge
	1	0
	very small	-1
	1	+1

(2 marks)

3



Turn over for the next question

**DO NOT WRITE ON THIS PAGE
ANSWER IN THE SPACES PROVIDED**

Turn over ►



8 A car has an oil leak. Every 5 seconds an oil drop falls from the bottom of the car onto the road.

8 (a) What force causes the oil drop to fall towards the road?

.....
(1 mark)

8 (b) The diagram shows the spacing of the oil drops left on the road during part of a journey from A to B.



Describe the motion of the car as it moves from **A** to **B**.

.....

Explain the reason for your answer.

.....
.....
.....
.....

(3 marks)

8 (c) When the brakes are applied, a braking force slows down and stops the car.

8 (c) (i) The size of the braking force affects the braking distance of the car.

State **one** other factor that affects the braking distance of the car.

.....
(1 mark)



8 (c) (ii) A braking force of 3 kN is used to slow down and stop the car in a distance of 25 m.

Calculate the work done by the brakes to stop the car and give the unit.

Use the correct equation from the Physics Equations Sheet.

.....
.....
.....

Work done =

(3 marks)

8

Turn over for the next question

Turn over ►



9 Stars go through a life cycle. About 90% of all stars are in the 'main sequence' period of the life cycle.

9 (a) Stars are stable during the 'main sequence' period of the life cycle.

Why?

.....

.....

(1 mark)

9 (b) The table gives an estimated time for the number of years that three stars, **X**, **Y** and **Z**, will be in the 'main sequence' period of their life cycle.

Star	Relative mass of the star compared to the Sun	Estimated 'main sequence' period in millions of years
X	0.1	4 000 000
Y	1.0	9 000
Z	40.0	200

9 (b) (i) This data suggests that there is a pattern linking the mass of a star and the number of years the star is in the 'main sequence' period of its life cycle.

What is the pattern suggested by the data?

.....

.....

(1 mark)

9 (b) (ii) Scientists cannot give the exact number of years a star will be in the 'main sequence' period.

Suggest why.

.....

.....

(1 mark)



9 (b) (iii) Nuclear fusion is the process by which energy is released in stars.

Which **one** of the following can be concluded from the data in the table?

Draw a ring around the correct answer in the box to complete the sentence.

The rate of nuclear fusion in a large star is

faster than
the same as
slower than

 in a small star.

Explain the reason for your answer.

.....
.....
.....
.....

(3 marks)

Question 9 continues on the next page

Turn over ►



There are no questions printed on this page

**DO NOT WRITE ON THIS PAGE
ANSWER IN THE SPACES PROVIDED**



There are no questions printed on this page

**DO NOT WRITE ON THIS PAGE
ANSWER IN THE SPACES PROVIDED**

