

Write your name here	
Surname	Other names
Centre Number	Candidate Number
<b>Edexcel GCSE</b>	
<b>Biology/Science</b>	
<b>Unit B1: Influences on Life</b>	
<b>Higher Tier</b>	
Tuesday 8 November 2011 – Afternoon <b>Time: 1 hour</b>	Paper Reference <b>5BI1H/01</b>
<b>You must have:</b> Calculator, ruler	Total Marks

### Instructions

- Use **black** ink or ball-point pen.
- **Fill in the boxes** at the top of this page with your name, centre number and candidate number.
- Answer **all** questions.
- Answer the questions in the spaces provided  
– *there may be more space than you need.*

### Information

- The total mark for this paper is 60.
- The marks for **each** question are shown in brackets  
– *use this as a guide as to how much time to spend on each question.*
- Questions labelled with an **asterisk** (\*) are ones where the quality of your written communication will be assessed  
– *you should take particular care with your spelling, punctuation and grammar, as well as the clarity of expression, on these questions.*

### Advice

- Read each question carefully before you start to answer it.
- Keep an eye on the time.
- Try to answer every question.
- Check your answers if you have time at the end.

P40175A

©2011 Edexcel Limited.  
1/1/1/1/



Turn over ►

**edexcel**   
advancing learning, changing lives

Answer ALL questions.

Some questions must be answered with a cross in a box ☒. If you change your mind about an answer, put a line through the box ☒ and then mark your new answer with a cross ☒.

**Water pollution**

1 Catherine is an environmentalist studying water pollution in the stream shown in the diagram.

She took samples of water from locations A, B and C and recorded the number of freshwater shrimps at each location on the diagram.

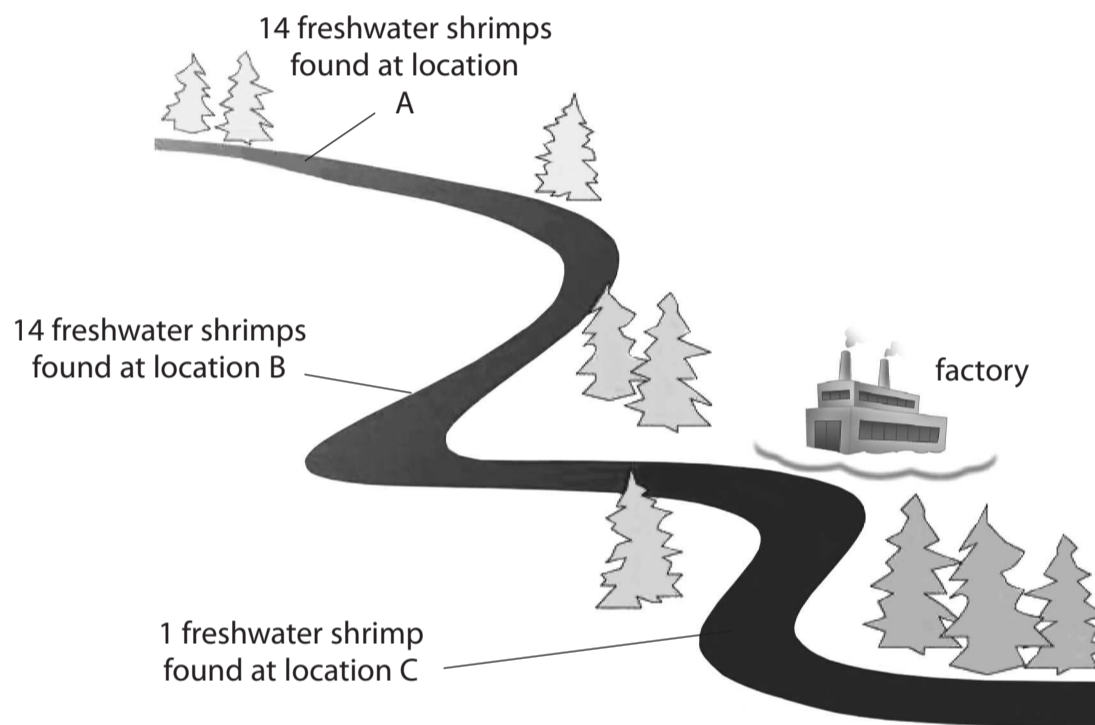

(a) Explain which location in the stream is most polluted.

(2)

.....

.....

.....

.....



(b) Complete the sentence by putting a cross (☒) in the box next to your answer.

Location A had other organisms present.

These organisms are likely to be

(1)

- A** blackspot fungus
- B** bloodworm
- C** sludgeworm
- D** stonefly

(c) Complete the sentence by putting a cross (☒) in the box next to your answer.

The factory shown in the diagram produces nitrate fertilisers.

Some nitrate fertilisers leaked into the stream and caused

(1)

- A** combustion
- B** decomposition
- C** eutrophication
- D** nitrification

(d) Describe what will happen to the organisms in the stream when nitrates leak from the factory.

(4)

.....

.....

.....

.....

.....

.....

.....

.....

.....

.....

**(Total for Question 1 = 8 marks)**



### Monohybrid inheritance

2 Cystic fibrosis is a genetic disorder caused by recessive alleles.

The diagram shows the inheritance of cystic fibrosis in a family.

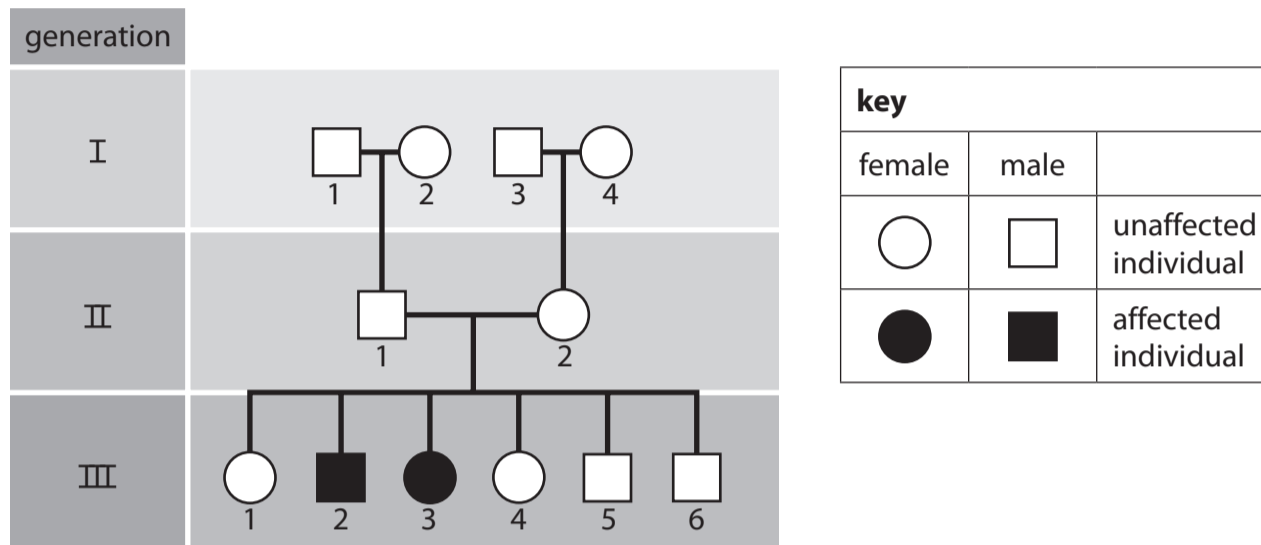

(a) (i) State the number of offspring in generation III who will have the disorder cystic fibrosis.

(1)

(ii) Complete the sentence by putting a cross (☒) in the box next to your answer.

In generation III, individual 3 is

(1)

- A a carrier of the cystic fibrosis allele
- B heterozygous for cystic fibrosis
- C homozygous dominant for cystic fibrosis
- D homozygous recessive for cystic fibrosis



(iii) Explain why both individuals in generation II must be heterozygous for cystic fibrosis.

(2)

.....

.....

.....

.....

(b) Complete the Punnett square to illustrate the inheritance of cystic fibrosis from the two heterozygous parents in generation II.

Use B for the dominant allele and b for the recessive allele.

(2)

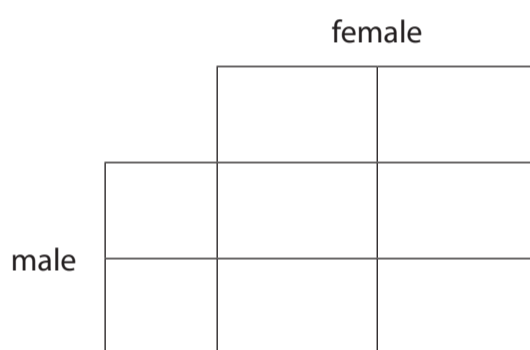

(c) Explain why pedigree analysis would be important to the unaffected individuals in generation III.

Use percentages or ratios to help illustrate this.

(2)

.....

.....

.....

.....

**(Total for Question 2 = 8 marks)**



**Energy**

3 Scientists can show the relationships between organisms in a variety of ways.

This food chain shows the energy content at each trophic level.

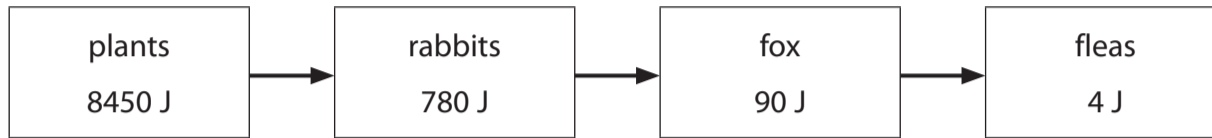

(a) (i) Calculate the percentage of energy that is transferred from the rabbits to the fox.

(2)

answer = .....%

(ii) State **two** ways in which energy can be lost between the trophic levels of the rabbit and the fox.

(2)

- 1 .....
- .....
- 2 .....
- .....



(b) Suggest how a farmer rearing chickens could limit energy loss from the chickens.

(2)

.....

.....

.....

.....

(c) (i) Complete the sentence by putting a cross (☒) in the box next to your answer.

Fleas are parasites that feed on foxes.

Another example of parasites are

(1)

- A cleaner fish
- B lichens
- C mistletoe
- D oxpeckers

(ii) Peas and beans are known as legumes.  
They form a mutualistic relationship with the bacteria in their roots.

Explain the importance of this mutualistic relationship to the legumes.

(3)

.....

.....

.....

.....

.....

.....

.....

**(Total for Question 3 = 10 marks)**



**BLANK PAGE**





**Human variation**

**4** Mike was investigating variation in a school of 650 students. He recorded the blood group and measured the heights of the students.

The graph shows the variation in blood group.

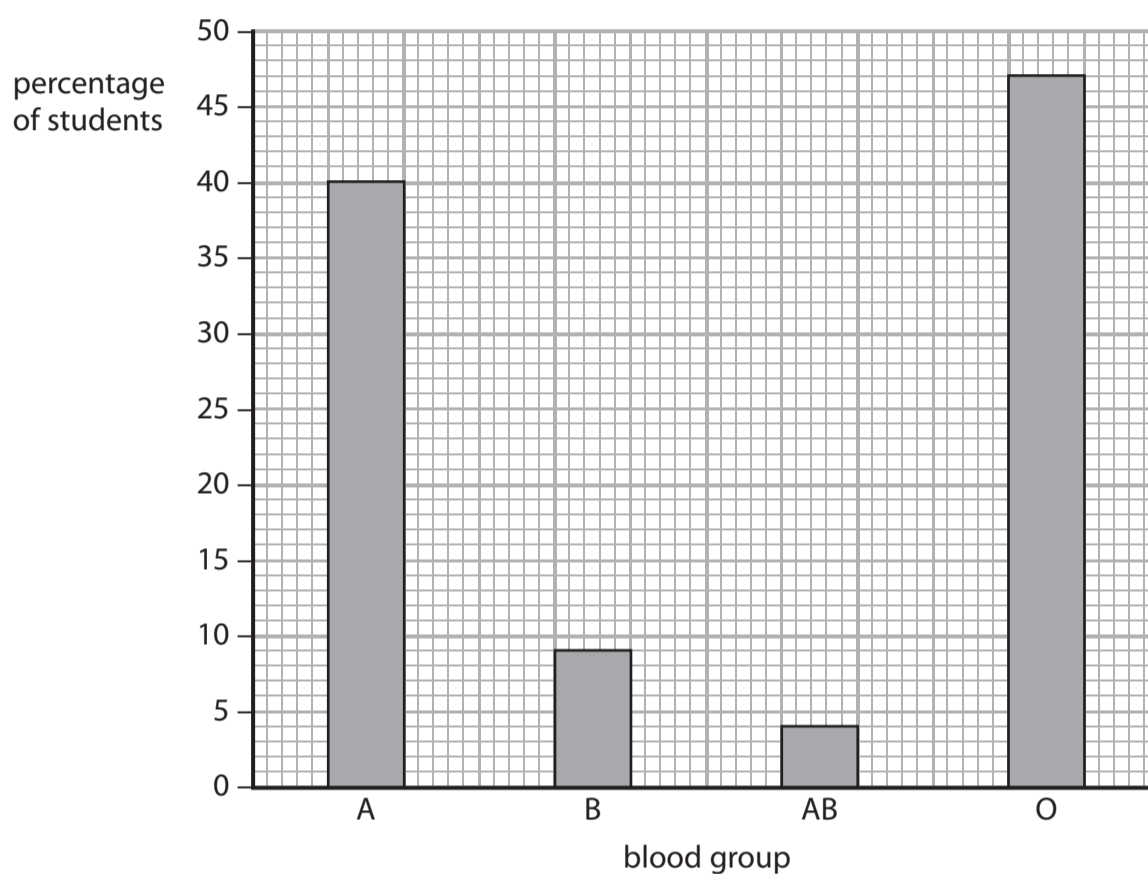

(a) (i) Calculate how many of the 650 students have blood group A. (2)

number of students with blood group A = .....

(ii) State the type of variation shown in the graph for the blood groups of students. (1)

.....



(b) The graph shows the variation in height.

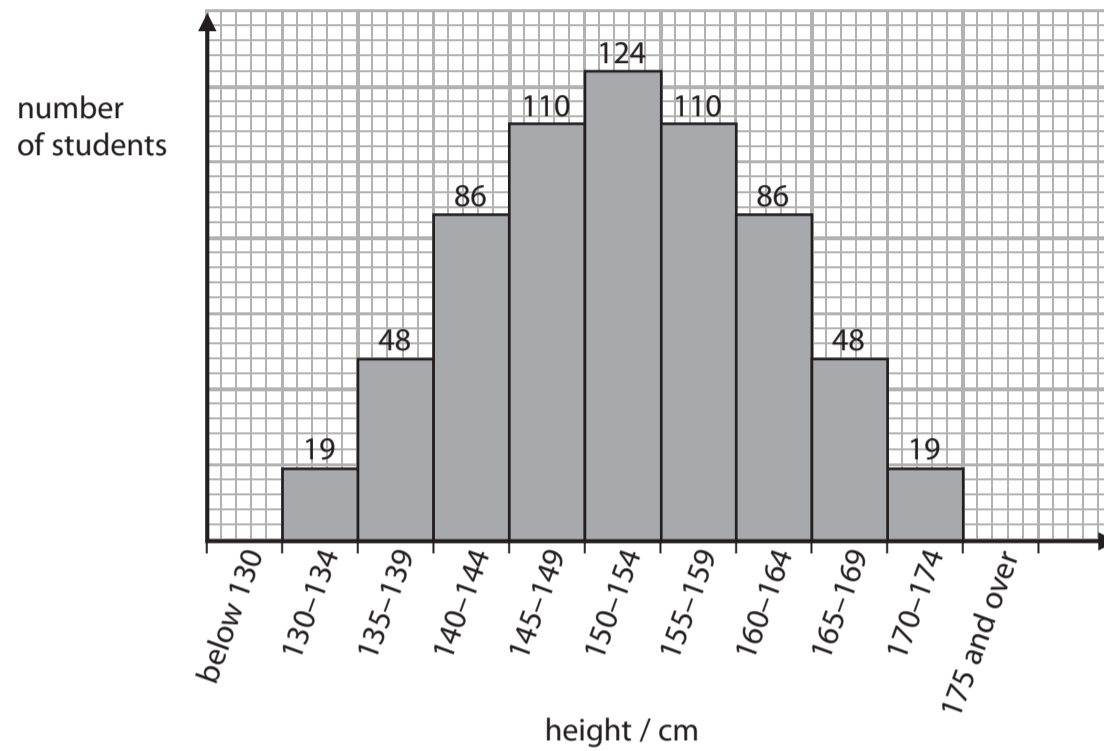

(i) Complete the sentence by putting a cross (☒) in the box next to your answer.

The range in heights of the students is due to

(1)

- A environmental influences only
- B genetic influences only
- C environmental and genetic influences
- D neither environmental nor genetic influences

(ii) Describe the variation in height of these students, as shown in the graph.

(3)

.....

.....

.....

.....

.....

.....



(c) Taller animals may have an evolutionary advantage.

Explain how evolution by natural selection brings about changes in a species.

(3)

.....

.....

.....

.....

.....

.....

.....

**(Total for Question 4 = 10 marks)**



### The carbon cycle

- 5 Carbon dioxide concentration in the air is thought to be changing as a result of human population increase.

The graph shows how the concentration of carbon dioxide in the atmosphere has changed in Europe between 1958 and 1992.

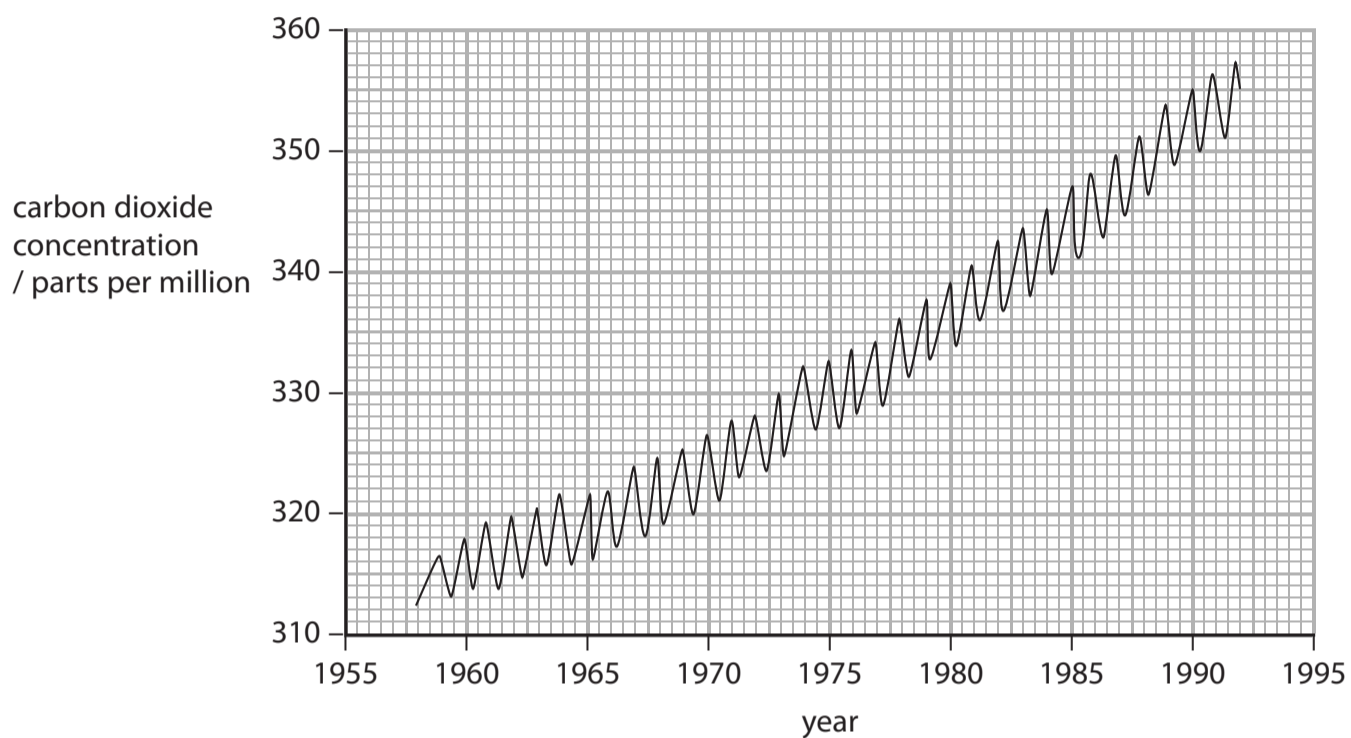

- (a) (i) Describe the main trend shown in the graph.

(1)

- (ii) Calculate the difference in atmospheric carbon dioxide concentration in Europe between 1980 and 1990.

(2)

answer = ..... parts per million



(iii) The carbon dioxide concentration changes during each year.

Suggest why the carbon dioxide concentration changes during a year.

(3)

.....

.....

.....

.....

.....

\*(b) Carbon is present in a wide variety of compounds in the carbon cycle.

Describe how carbon is cycled in the environment.

(6)

.....

.....

.....

.....

.....

.....

.....

.....

.....

.....

.....

.....

.....

.....

.....

.....

.....

.....

.....

.....

.....

.....

(Total for Question 5 = 12 marks)



### Thermoregulation

6 (a) The diagram shows the regulation of body temperature.

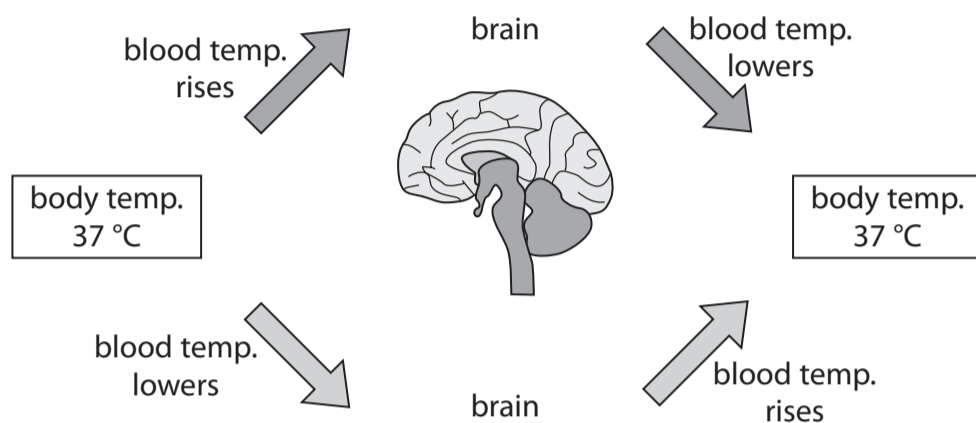

(i) Complete the sentence by putting a cross (☒) in the box next to your answer.

The type of control shown in the diagram is known as

(1)

- A negative feedback
- B osmoregulation
- C positive feedback
- D variation

(ii) State the part of the brain that controls body temperature.

(1)

(b) Describe **one** way in which the skin helps in the control of body temperature.

(2)

.....

.....

.....

.....

.....



(c) Explain why humans need to maintain their body temperature at 37 °C.

(2)

.....

.....

.....

.....

\*(d) Explain how changes in the volume of blood going through the skin help to maintain body temperature.

(6)

.....

.....

.....

.....

.....

.....

.....

.....

.....

.....

.....

.....

.....

.....

.....

.....

.....

.....

.....

.....

.....

**(Total for Question 6 = 12 marks)**

**TOTAL FOR PAPER = 60 MARKS**



**BLANK PAGE**

