

Centre Number						Candidate Number				
Surname										
Other Names										
Candidate Signature										



General Certificate of Secondary Education
Higher Tier
June 2013

Mathematics (Linear)

43652H

Paper 2

Friday 14 June 2013 9.00 am to 11.00 am

H

<p>For this paper you must have:</p> <ul style="list-style-type: none"> • a calculator • mathematical instruments. 	
---	--

Time allowed

- 2 hours

Instructions

- Use black ink or black ball-point pen. Draw diagrams in pencil.
- Fill in the boxes at the top of this page.
- Answer **all** questions.
- You must answer the questions in the spaces provided. Do not write outside the box around each page or on blank pages.
- Do all rough work in this book.

Information

- The marks for questions are shown in brackets.
- The maximum mark for this paper is 105.
- The quality of your written communication is specifically assessed in Questions 5, 7 and 16. These questions are indicated with an asterisk (*).
- You may ask for more answer paper, tracing paper and graph paper. These must be tagged securely to this answer book.

Advice

- In all calculations, show clearly how you work out your answer.

For Examiner's Use	
Examiner's Initials	
Pages	Mark
2 – 3	
4 – 5	
6 – 7	
8 – 9	
10 – 11	
12 – 13	
14 – 15	
16 – 17	
18 – 19	
20 – 21	
22 – 23	
24 – 25	
26 – 27	
TOTAL	



J U N 1 3 4 3 6 5 2 H 0 1

Formulae Sheet: Higher Tier

Area of trapezium = $\frac{1}{2}(a+b)h$

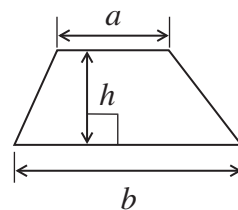

Volume of prism = area of cross-section \times length

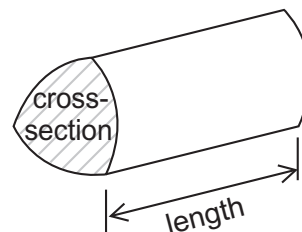

Volume of sphere = $\frac{4}{3}\pi r^3$

Surface area of sphere = $4\pi r^2$

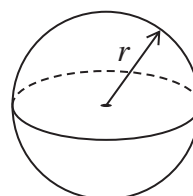

Volume of cone = $\frac{1}{3}\pi r^2 h$

Curved surface area of cone = $\pi r l$

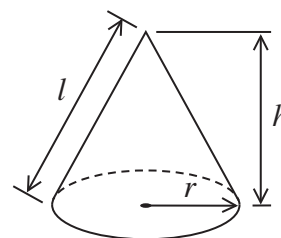

In any triangle ABC

Area of triangle = $\frac{1}{2}ab \sin C$

Sine rule $\frac{a}{\sin A} = \frac{b}{\sin B} = \frac{c}{\sin C}$

Cosine rule $a^2 = b^2 + c^2 - 2bc \cos A$

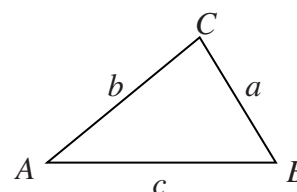

The Quadratic Equation

The solutions of $ax^2 + bx + c = 0$, where $a \neq 0$, are given by

$$x = \frac{-b \pm \sqrt{(b^2 - 4ac)}}{2a}$$



Answer **all** questions in the spaces provided.

- 1** This formula is used for working out the cost, £ C , of repairing a car.

$$C = nL + 1.2P$$

n is the number of hours worked

L is the labour rate (£)

P is the cost of parts (£)

- 1 (a)** Work out the cost of repairing a car when

$$n = 3$$

$$L = 18$$

$$P = 110$$

.....

.....

.....

Answer £ (2 marks)

- 1 (b)** Complete this table for another repair.

C	n	L	P
£ 235		£ 22	£ 150

(3 marks)

5

Turn over ►



2 The scatter diagram shows the scores of 10 students in their Oral and Written tests.

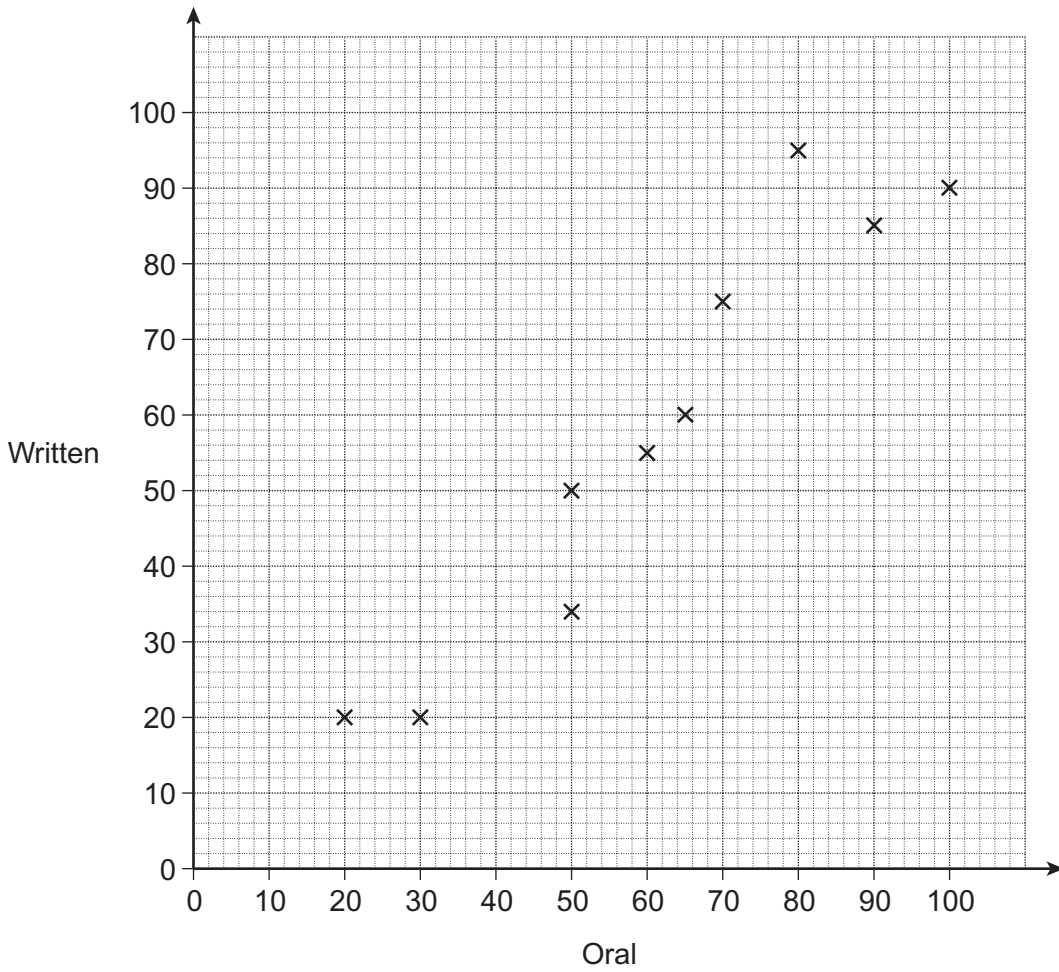

2 (a) How many students scored 50 in their Oral test?

Answer (1 mark)

2 (b) Four **more** students take the same tests. The table shows their scores.

Oral	10	94	52	84
Written	15	90	46	80

Plot the scores on the scatter diagram.

(2 marks)



2 (c) Draw a line of best fit on the scatter diagram. (1 mark)

2 (d) Rob scored 40 in the Oral test. He was absent for the Written test. Use your line of best fit to estimate a score for him in the Written test. Answer (1 mark)

3 Andrew is planning a survey about his local library. Here is one of his questions with a response section.

How many times do you go to the library?

1	2	3	5 or more
<input type="checkbox"/>	<input type="checkbox"/>	<input type="checkbox"/>	<input type="checkbox"/>

3 (a) Give one criticism of the question. (1 mark)

3 (b) Give two criticisms of the response section. Criticism 1 Criticism 2 (2 marks)



- 4 The diagram shows a kite.

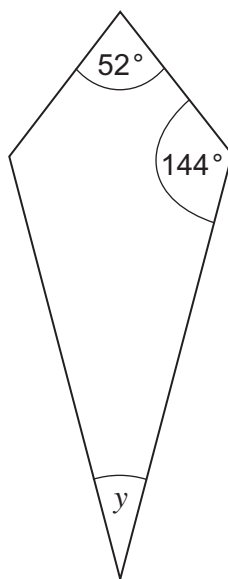

Not drawn accurately

Work out the size of angle y .

.....

.....

.....

.....

Answer degrees (2 marks)



*5 DVD cases are packed in this box.

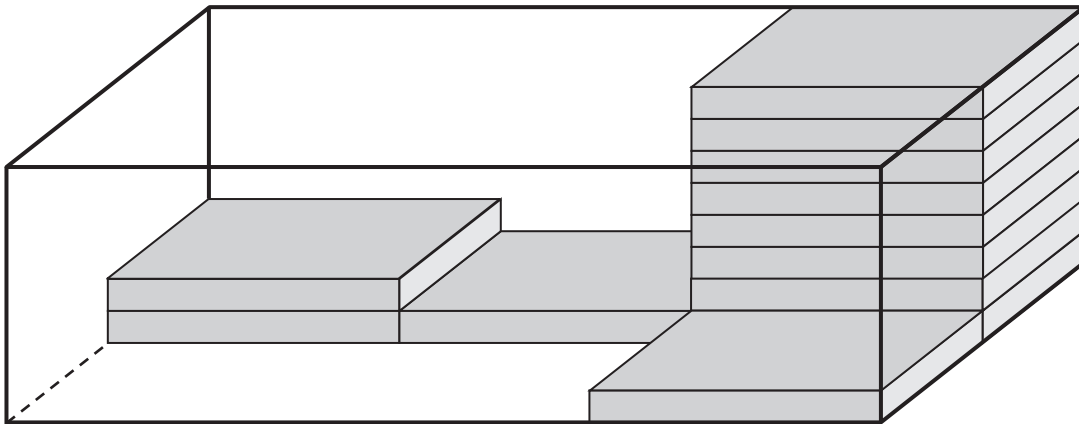

Jenny buys a **full** box of cases for £2.43
 She sells all the cases for 11 pence each.
 She saves **two-thirds** of the profit.

How much money does she save?

.....

.....

.....

.....

.....

.....

.....

Answer £ (5 marks)



- 6 The perimeter of this triangle is 48 cm.

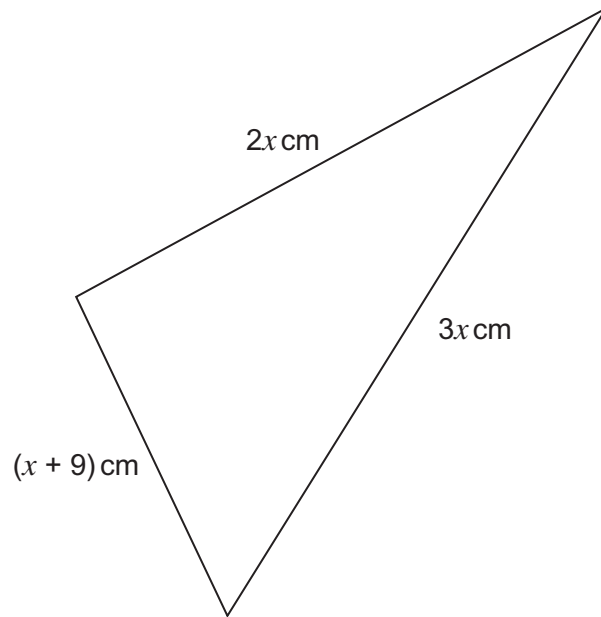

Work out the value of x .

.....

.....

.....

.....

$x =$ cm (4 marks)



*7 Here are two ways of having a car for one year.

Buy and sell

Buy it for £ 12 000

Sell it for £ 10 000 after one year

Rent

Normal Price: £ 195 per month

Special Offer 15% off

Which way is cheaper?
You **must** show your working.

.....

.....

.....

.....

.....

.....

.....

Answer (5 marks)

Turn over for the next question



8 (a) A speed camera takes two photographs of a car.

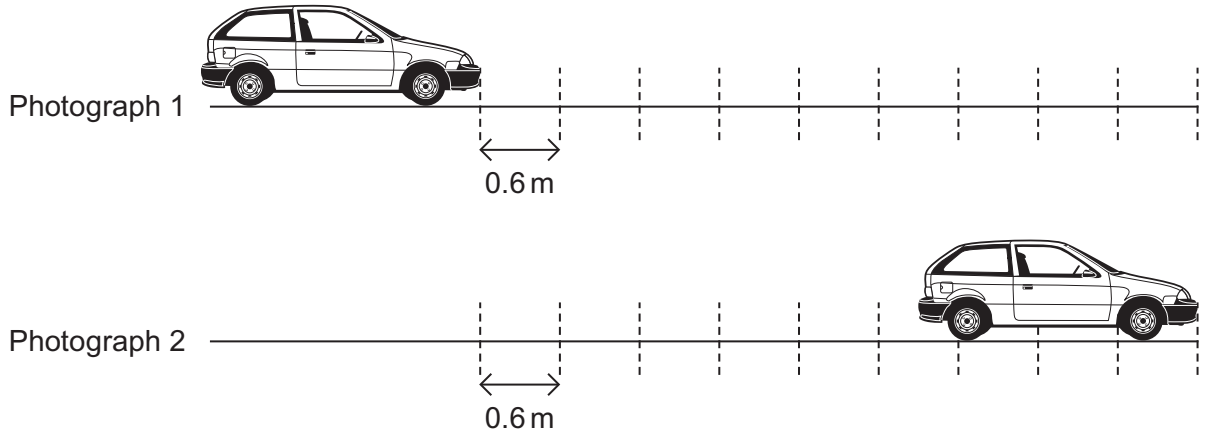

Photograph 2 was taken 0.5 seconds after Photograph 1.
Marks on the road are 0.6 metres apart.

Calculate the average speed of the car in m/s.

.....
.....
.....

Answer m/s (3 marks)



8 (b) You are given that

1 kilometre = 1000 metres

and

1 hour = 3600 seconds

A lorry is travelling at 13.6 m/s.
The speed limit is 50 km/h.

Show that the lorry is travelling below the speed limit.

.....
.....
.....
.....

(3 marks)

9 A tank contains 0.6 m³ of water.
The water is used to fill pots.
Each pot can hold 1250 cm³ of water.

How many pots can be filled?

.....
.....
.....
.....
.....

Answer (3 marks)



10 150 boys and 160 girls sit an examination.
The table shows some of the probabilities that they came with or without a calculator.

	With calculator	Without calculator
Boy	0.92	0.08
Girl	0.95	

10 (a) What is the probability that a girl came **without** a calculator?
Write your answer in the table.

(1 mark)

10 (b) How many of the 150 boys came **with** a calculator?

.....

.....

.....

.....

.....

Answer (2 marks)



11 These two triangles are congruent.

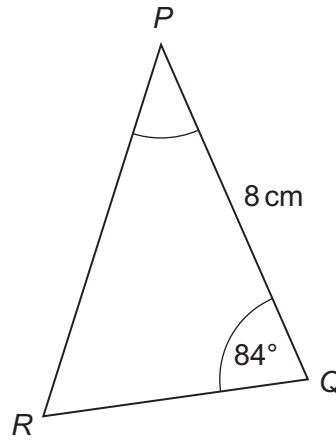
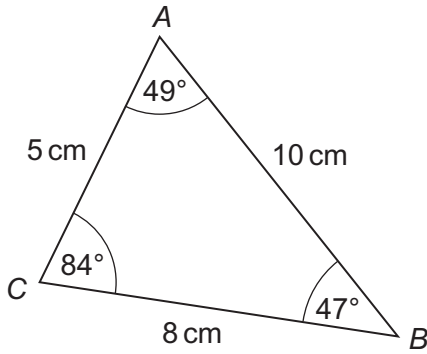

11 (a) What is the size of angle P ?
Circle your answer.

47°

49°

84°

none of these

(1 mark)

11 (b) What is the length of PR ?
Circle your answer.

5 cm

8 cm

10 cm

none of these

(1 mark)

Turn over for the next question



12 The perimeter of this square is 48 cm.

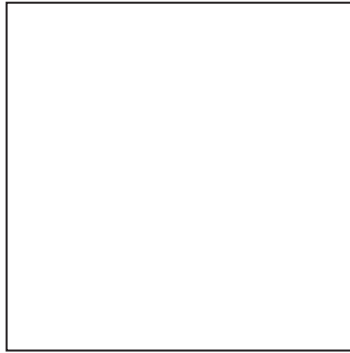

Semicircles are joined to two sides of the square.

Not drawn
accurately

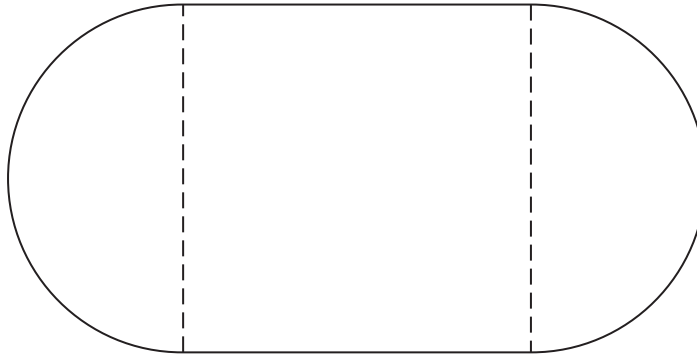

Work out the perimeter of this shape.

.....

.....

.....

.....

.....

.....

Answer cm (4 marks)



13 Amy raised £ n for charity.
Chris raised £ 18 more than Amy.

The **mean** amount raised by the two of them is £ 45.

Work out how much money each one of them raised.

.....

.....

.....

.....

.....

.....

.....

.....

.....

Amy £

Chris £ (5 marks)

Turn over for the next question



14 (a) Work out $(6.45 \times 10^6) \times (2.5 \times 10^{-4})$

Write your answer in standard form.

Answer (2 marks)

14 (b) Here is a number machine.

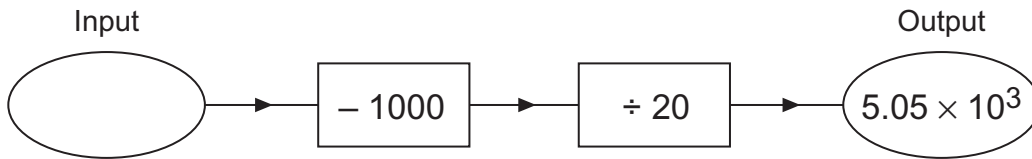

Work out the **input** when the output is 5.05×10^3

Write your answer in standard form.

Answer (3 marks)

15 (a) Work out the value of $x^3 - 2x + 7$ when $x = -2.5$

Answer (1 mark)

15 (b) Factorise fully $4x^2 + 6xy$

.....
.....

Answer (2 marks)



***16** Here is part of a shopping bill for clothing.

1 jacket at	
1 shirt at £ 29	
Total cost before discount =	
10% discount	
Total to pay after discount =	£ 80.10

Work out the cost of the jacket **before** the discount.

.....

.....

.....

.....

.....

.....

Answer £ (5 marks)

Turn over for the next question



- 17** A is the point with coordinates $(x, 2y)$.
 B is the point with coordinates $(3x, 4y)$.
The midpoint of AB has coordinates $(-4, 15)$.

Work out the values of x and y .

.....

.....

.....

.....

.....

.....

.....

$$x = \text{.....}$$

$$y = \text{.....} \quad (4 \text{ marks})$$



18 (a) Work out the size of angle x .

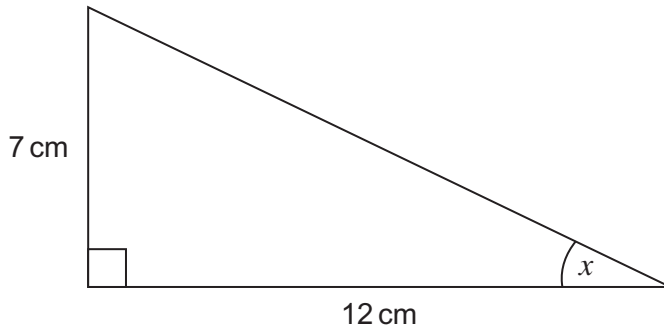

Not drawn accurately

.....

.....

.....

.....

Answer degrees (3 marks)

18 (b) Work out the length BC .

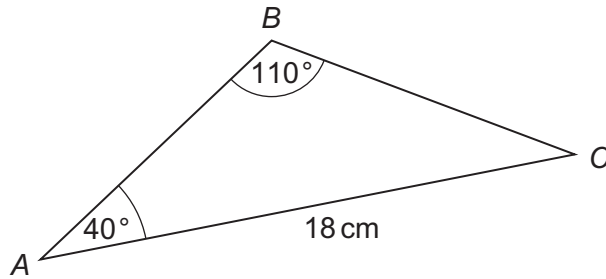

Not drawn accurately

.....

.....

.....

.....

Answer cm (3 marks)

10

Turn over ►



19 (a) The table shows information about the travel expenses of employees at a company.

All amounts are in £.

Minimum	Lower quartile	Median	Upper quartile	Maximum
9	18	23	30	45

Draw a box plot to show this information.

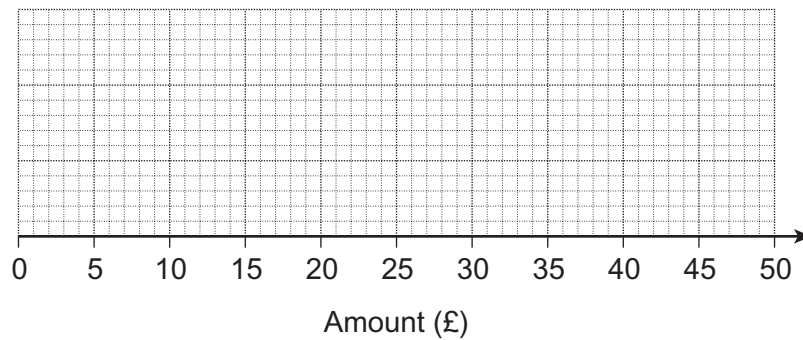

(2 marks)



19 (b) This table shows information about the distances the employees travel to work.

Distance, D (km)	Frequency
$0 < D \leq 10$	17
$10 < D \leq 15$	12
$15 < D \leq 30$	3
$30 < D \leq 60$	9

Draw a histogram to show this information.

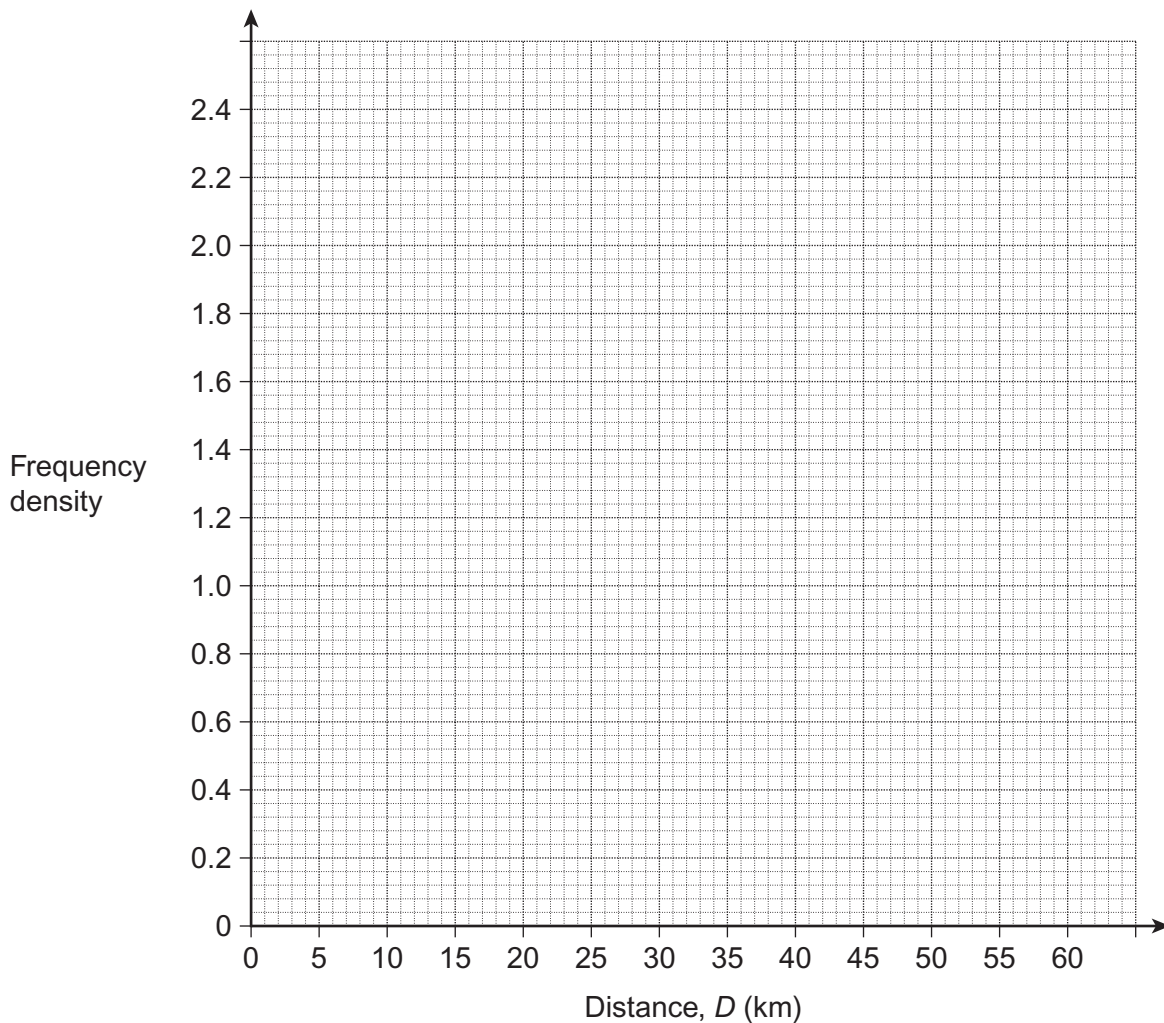

(3 marks)



20 Solve the equation $2x^2 + 8x + 5 = 0$
Give your answers to 2 decimal places.

.....

.....

.....

.....

.....

.....

.....

.....

Answer (3 marks)

21 The expression $\frac{x^2 - 9}{x^2 + bx - 15}$ simplifies to $\frac{x + 3}{x + 5}$

Work out the value of b .

.....

.....

.....

.....

.....

$b =$ (3 marks)



22

A and B are two similar solids.

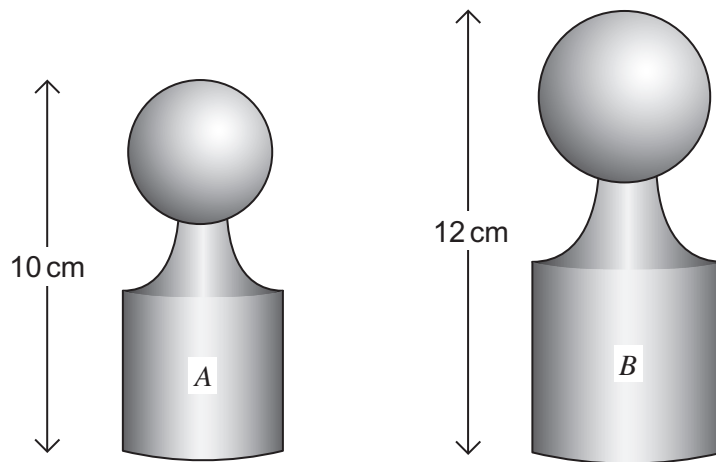

The volume of A is 500 cm^3 .

Work out the volume of B .

.....

.....

.....

.....

.....

.....

Answer cm^3 (3 marks)



23

A bag contains 12 counters.
Five of the counters are white.

A counter is taken out of the bag at random and **not** replaced.
A second counter is taken out of the bag at random.

Calculate the probability that **only one** of the two counters is white.

.....

.....

.....

.....

.....

.....

Answer (3 marks)



24 AB is parallel to DC .

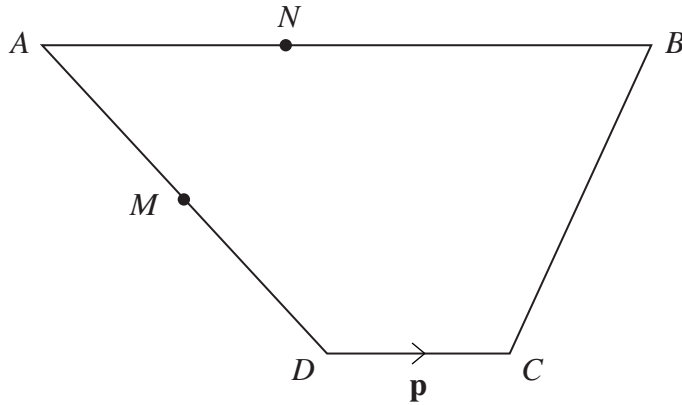

Not drawn
accurately

$$\vec{AB} = 5\mathbf{p}$$

$$\vec{DC} = \mathbf{p}$$

$$\vec{DA} = 2\mathbf{q} - \mathbf{p}$$

24 (a) Show that $\vec{CB} = 2\mathbf{q} + 3\mathbf{p}$

.....

.....

.....

(1 mark)

24 (b) M is the midpoint of AD .

$$\vec{AN} : \vec{NB} = 2 : 3$$

Show that MN is parallel to CB .

.....

.....

.....

.....

.....

(4 marks)

8

Turn over ►



25 (a) On this grid draw the graph of $y = 1 + \sin x$ for values of x from 0° to 360° .

The graph of $y = \sin x$ has been drawn to help you.

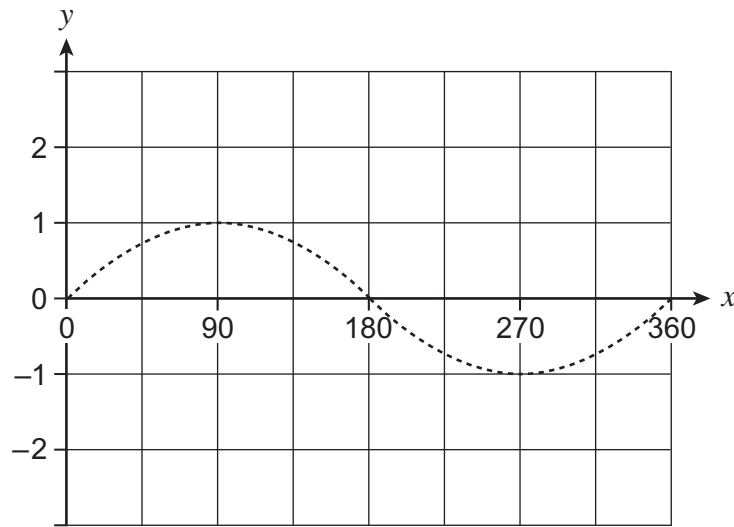

(1 mark)

25 (b) On this grid draw the graph of $y = 2 \sin x$ for values of x from 0° to 360° .

The graph of $y = \sin x$ has been drawn to help you.

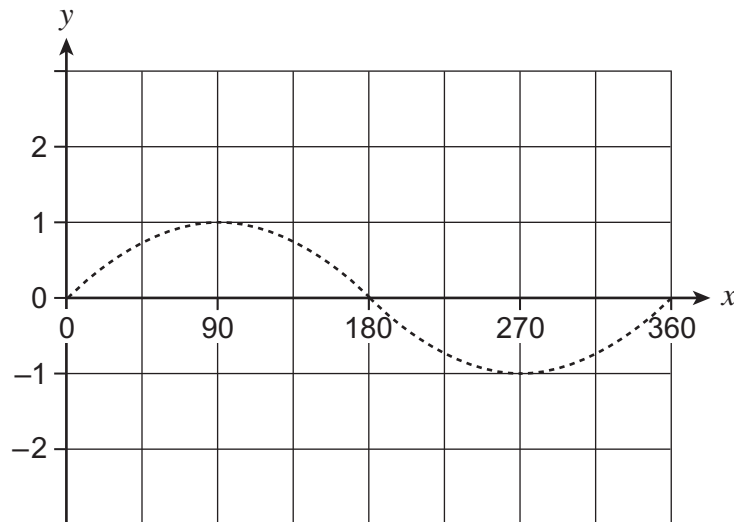

(1 mark)



26

Solve the equation

$$\frac{5}{x+2} + \frac{4}{x+1} = 2$$

.....

.....

.....

.....

.....

.....

.....

.....

.....

.....

.....

.....

.....

.....

.....

.....

.....

.....

.....

.....

.....

.....

Answer (6 marks)

END OF QUESTIONS

8



There are no questions printed on this page

**DO NOT WRITE ON THIS PAGE
ANSWER IN THE SPACES PROVIDED**

