

Please write clearly in block capitals.

Centre number

Candidate number

Surname _____

Forename(s) _____

Candidate signature _____

I declare this is my own work.

GCSE PHYSICS

H

Higher Tier Paper 2

Time allowed: 1 hour 45 minutes

Materials

For this paper you must have:

- a ruler
- a scientific calculator
- a protractor
- the Physics Equations Sheet (enclosed).

Instructions

- Use black ink or black ball-point pen. Pencil should only be used for drawing.
- Fill in the boxes at the top of this page.
- Answer **all** questions in the spaces provided.
- Do not write outside the box around each page or on blank pages.
- Do all rough work in this book. Cross through any work you do not want to be marked.
- If you need extra space for your answer(s), use the lined pages at the end of this book. Write the question number against your answer(s).
- In all calculations, show clearly how you work out your answer.

Information

- The maximum mark for this paper is 100.
- The marks for questions are shown in brackets.
- You are expected to use a calculator where appropriate.
- You are reminded of the need for good English and clear presentation in your answers.

For Examiner's Use	
Question	Mark
1	
2	
3	
4	
5	
6	
7	
8	
TOTAL	



Answer **all** questions in the spaces provided.

*Do not write
outside the
box*

0 1

Figure 1 shows an electric super-car.

Figure 1



0 1 . 1

The battery in an electric car needs to be recharged.

Suggest **two** factors that affect the distance an electric car can travel before the battery needs to be recharged.

[2 marks]

1 _____

2 _____



Use the Physics Equations Sheet to answer questions **01.2** and **01.3**.

0 1 . 2

Write down the equation which links acceleration (a), change in velocity (Δv) and time taken (t).

[1 mark]

0 1 . 3

The maximum acceleration of the car is 20 m/s^2 .

Calculate the time taken for the speed of the car to change from 0 m/s to 28 m/s at its maximum acceleration.

[3 marks]

Time taken = _____ s

Question 1 continues on the next page



0 1 . 4 In a trial run, the car accelerates at 10 m/s^2 until it reaches its final velocity.

distance travelled by the car = 605 m

initial velocity of the car = 0 m/s

Calculate the final velocity of the car.

Use the Physics Equations Sheet.

[3 marks]

Final velocity = _____ m/s



Use the Physics Equations Sheet to answer questions **01.5** and **01.6**.

01.5 Write down the equation which links distance (s), force (F) and work done (W).

[1 mark]

01.6 When travelling at its maximum speed the air resistance acting on the car is 4000 N.

Calculate the work done against air resistance when the car travels a distance of 7.5 km at its maximum speed.

[3 marks]

Work done = _____ J

13

Turn over for the next question

Turn over ►



0 2

A student used a ray box to shine a ray of light through air into a glass block.

The student investigated how the angle of refraction varied with the angle of incidence.

Table 1 shows the results.

Table 1

Angle of incidence in degrees	Angle of refraction in degrees
10	5
20	10
30	14
40	19
50	23
60	26
70	28
80	29

0 2 . 1

Describe a method the student could have used to obtain the results in **Table 1**.

Your answer may include a labelled diagram.

[6 marks]



0 2 . 2 Figure 2 is an incomplete graph of the results.

Figure 2

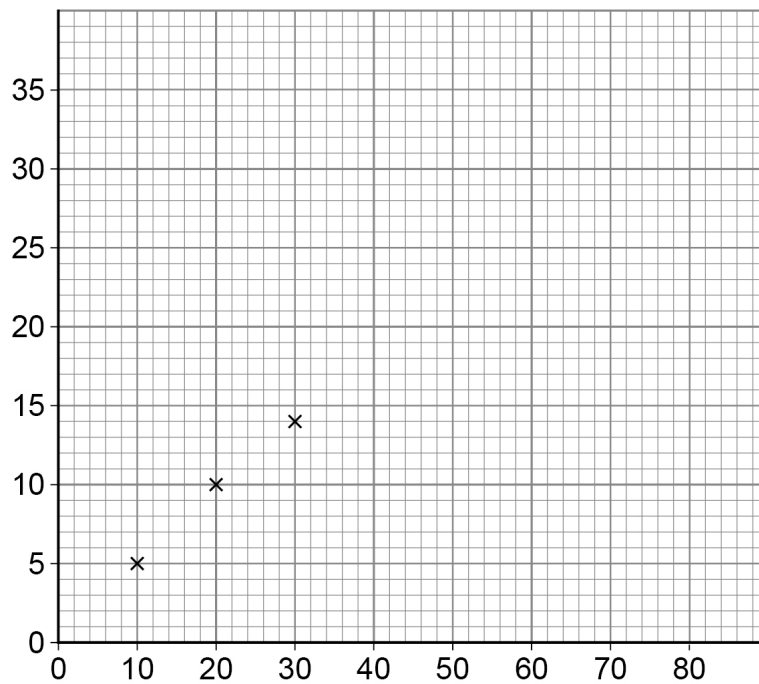

Complete **Figure 2** using data from **Table 1**.

- Label the axes.
- Plot the remaining data.
- Draw a line of best fit.

[4 marks]

Question 2 continues on the next page



0 2 . 3

Complete the ray diagram in **Figure 3** to show the reflection of light from the surface of a plane mirror.

You should:

- draw the normal line
- draw the reflected ray.

[2 marks]

Figure 3

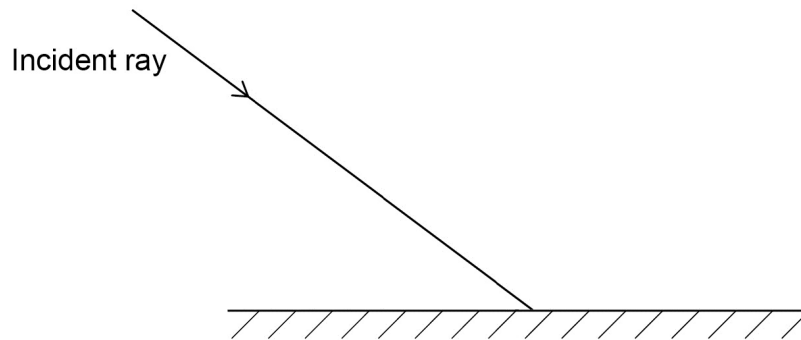

0 2 . 4 Two students investigated the reflection of light by a plane mirror.

Figure 4 shows the different equipment the students used.

Figure 4

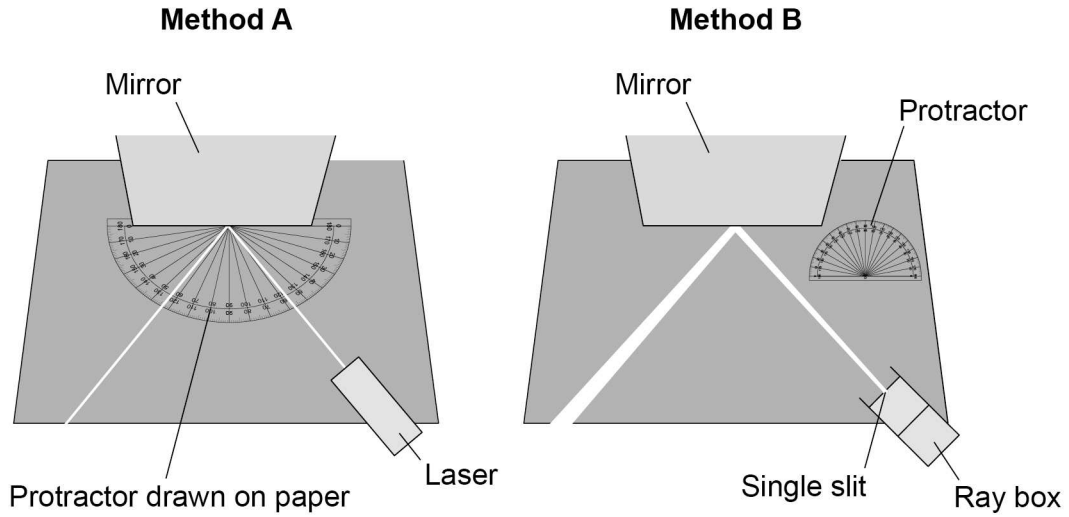

Explain **two** ways that **Method A** is better than **Method B**.

[4 marks]

1 _____

2 _____

16

Turn over for the next question

Turn over ►



0	3
---	---

Speed limits on roads increase safety.

0	3	.	1
---	---	---	---

The braking distance of a car increases as the speed of the car increases.

Give two **other** factors that **increase** the braking distance of a car.

[2 marks]

1 _____

2 _____

0	3	.	2
---	---	---	---

Explain why the driver's reaction time affects the thinking distance of a car.

[2 marks]



0 3 . 3 Scientists have investigated how drinking alcohol affects a person's reaction time.

Figure 5 shows the results of the investigation.

Figure 5

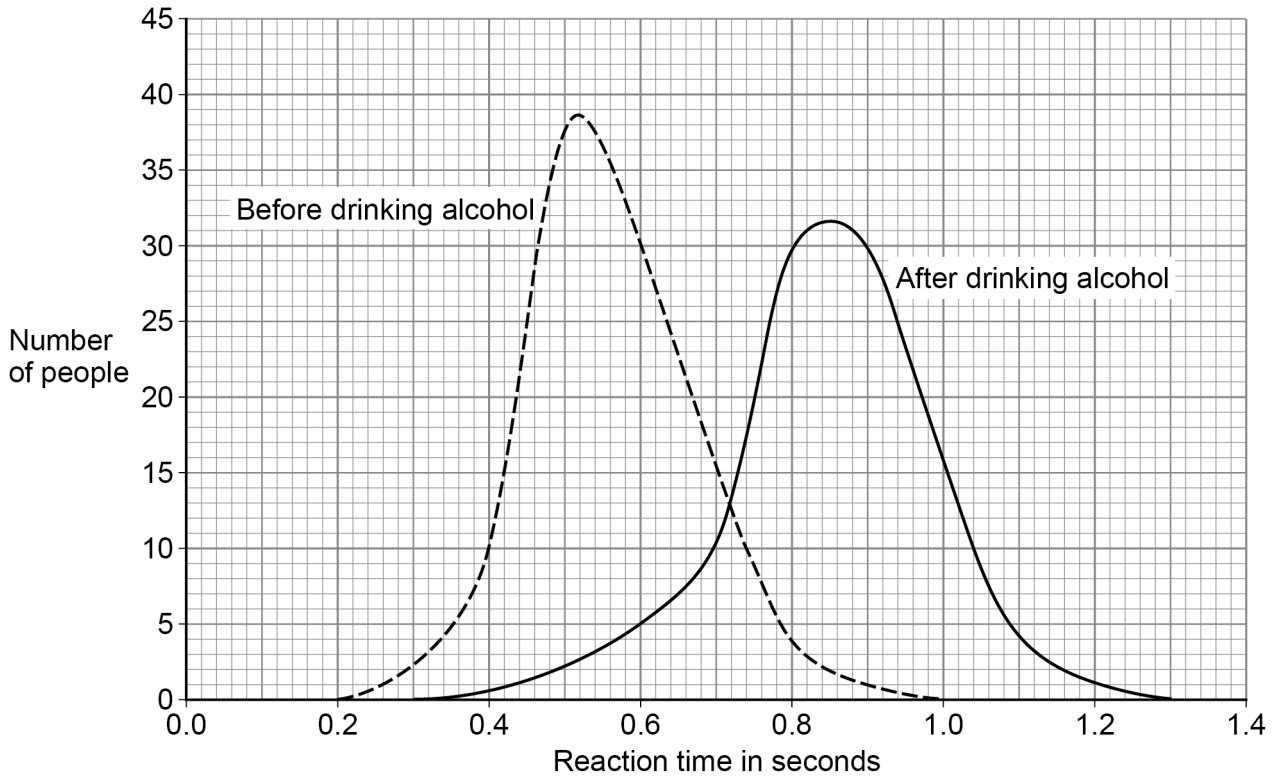

Which of the following conclusions can be made using **Figure 5**?

[2 marks]

Tick (✓) **two** boxes.

Every person's reaction time increases after drinking alcohol.

Mean reaction time increases after drinking alcohol.

Some people's reaction time is not affected by drinking alcohol.

The change in reaction time is not the same for all people after drinking alcohol.

There is a smaller range of reaction times after drinking alcohol.

Question 3 continues on the next page

Turn over ►



Figure 6 shows some speed cameras on a road.

The speed cameras determine the average speed of cars on the road.

Figure 6

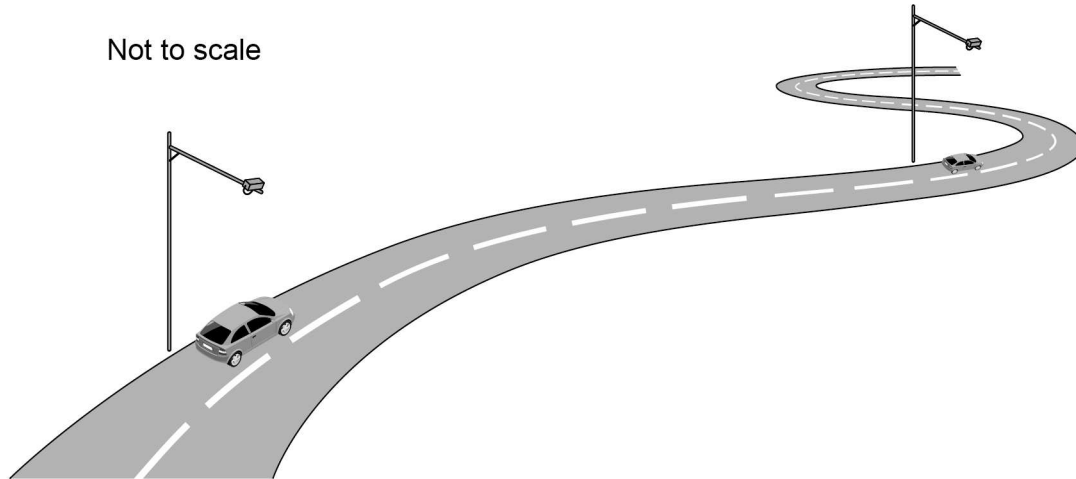

0 3 . 4

The speed limit on the road in **Figure 6** is 20 m/s.

The cameras in **Figure 6** are 1.5 km apart.

Calculate the minimum time it takes to travel 1.5 km without breaking the speed limit.

Use the Physics Equations Sheet.

[4 marks]

Minimum time = _____ s

Do not write
outside the
box



0 3 . 5

The average speed of a car between the cameras and the average velocity of the car between the cameras are different.

Explain why.

[3 marks]

13

Turn over for the next question

Turn over ►



There are no questions printed on this page

*Do not write
outside the
box*

**DO NOT WRITE ON THIS PAGE
ANSWER IN THE SPACES PROVIDED**



0 4

Hailstones are small balls of ice. Hailstones form in clouds and fall to the ground.

Figure 7 shows different-sized hailstones.

Figure 7



A hailstone falls from a cloud and accelerates.

0 4 . 1

Why does the hailstone accelerate?

[1 mark]

0 4 . 2

The hailstone stops accelerating and reaches terminal velocity.

Explain why the hailstone reaches terminal velocity.

[3 marks]

Turn over ►



A scientist investigated how the mass of hailstones affects their terminal velocity.

Figure 8 shows the results.

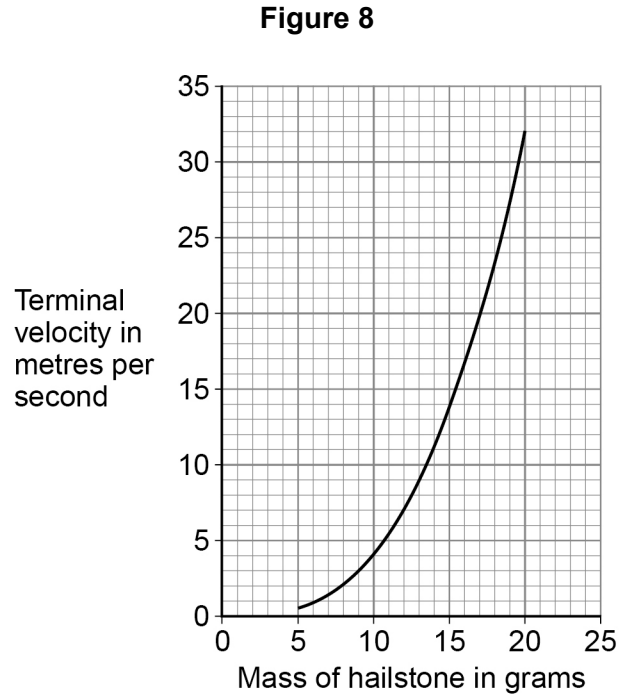

0 4 . 3 Why does terminal velocity increase with mass?

[1 mark]

Tick (✓) **one** box.

As mass increases the cross-sectional surface area of a hailstone increases.

As mass increases the volume of a hailstone increases.

As mass increases the weight of a hailstone increases.



0 4 . 4

Explain the difference in the maximum kinetic energy of a hailstone with a mass of 10 g and a hailstone with a mass of 20 g.

[3 marks]

0 4 . 5

The kinetic energy of a hailstone is measured in joules.

Which of the following is the same as 1 joule?

[1 mark]

Tick (✓) **one** box.

1 N m

1 N/m

1 N/m²1 N m²

Question 4 continues on the next page

Turn over ►

Figure 8 is repeated below.

Figure 8

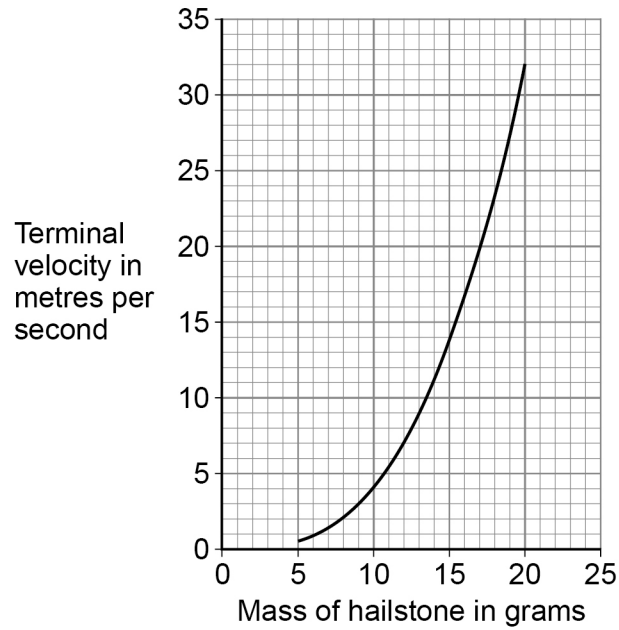

0 4 . 6 A hailstone hit the ground at its terminal velocity of 25 m/s.

The hailstone took 0.060 s to stop moving.

Determine the average force on the hailstone as it hit the ground.

Use information from **Figure 8**.

Use the Physics Equations Sheet.

[3 marks]

Average force = _____ N

12



Turn over for the next question

*Do not write
outside the
box*

**DO NOT WRITE ON THIS PAGE
ANSWER IN THE SPACES PROVIDED**

Turn over ►



0 5

Figure 9 shows a balance used to measure the mass of five tomatoes.

Figure 9

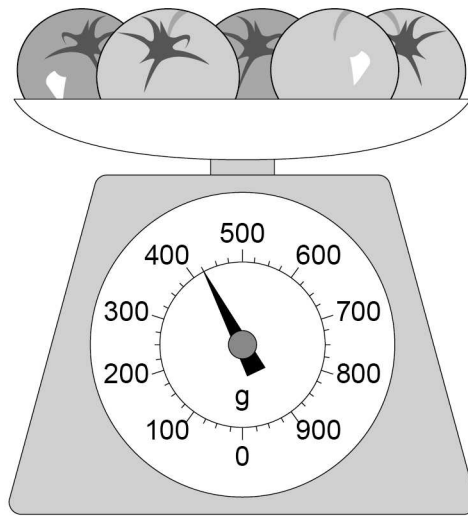

0 5 . 1

What is meant by 'centre of mass'?

[1 mark]

0 5 . 2

Calculate the mean weight of a tomato in **Figure 9**.

Use the Physics Equations Sheet.

gravitational field strength = 9.8 N/kg

[3 marks]

Weight = _____ N



0 5 . 3

The balance in **Figure 9** contains a spring that compresses when the tomatoes are placed on the balance.

Figure 10 shows the spring with no force acting and with a 6.0 N force acting.

Figure 10

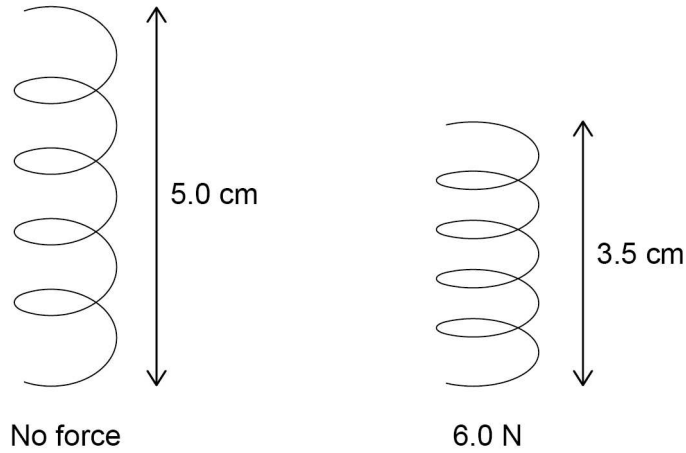

Determine the spring constant of the spring.

Use the Physics Equations Sheet.

[3 marks]

Spring constant = _____ N/m

0 5 . 4

Explain **one** property of the spring that makes it suitable for use in the balance.

[2 marks]



The points on **Figure 11** represent galaxies that are moving away from the Milky Way.

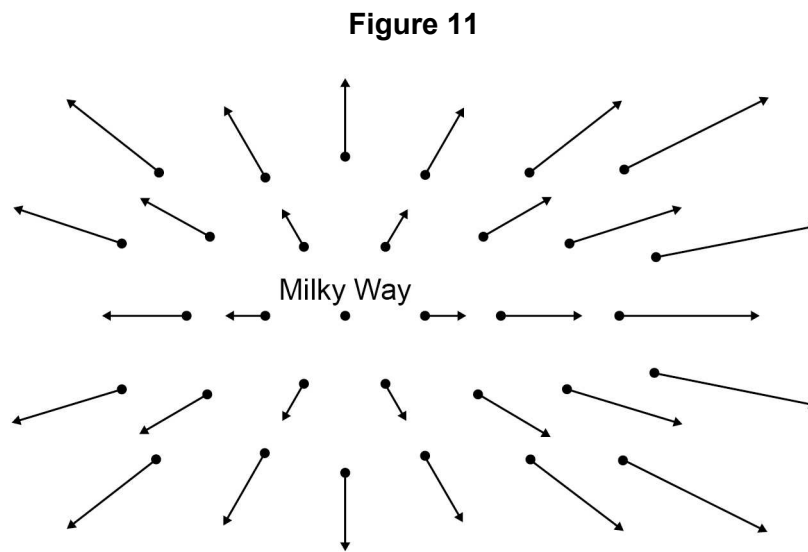

Each arrow represents the velocity of the galaxy relative to the Milky Way.

0 6 . 2

Light from all galaxies represented in **Figure 11** is red-shifted.

Describe what is meant by red-shift.

[2 marks]

0 6 . 3

Explain how **Figure 11** provides evidence for the Big Bang theory.

[2 marks]

0 6 . 4

Sometimes scientists have to change theories about the universe.

Give the reason why.

[1 mark]



07

The National Grid uses transformers to change potential difference (pd).

Figure 12 shows a transformer.

Figure 12

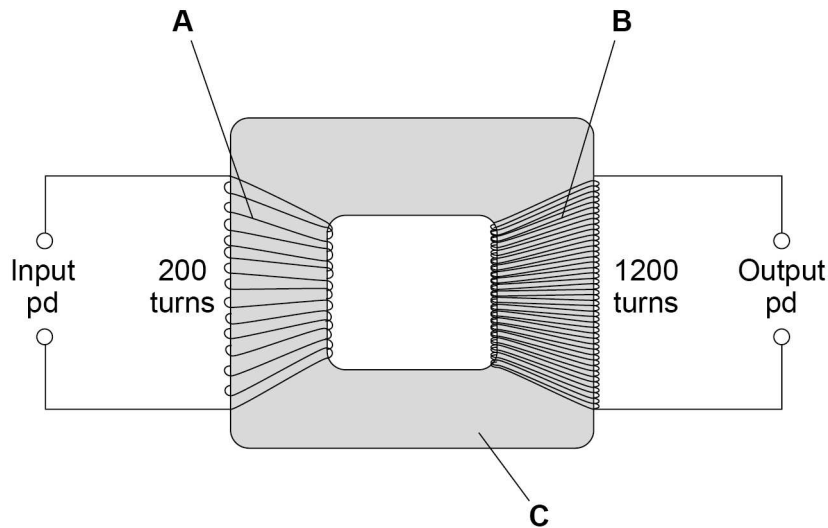

07.1

Identify the parts of the transformer labelled in Figure 12.

[2 marks]

A _____

B _____

C _____

07.2

There is an alternating input pd of 230 V.

Determine the output pd.

Use the Physics Equations Sheet.

[3 marks]

Output pd = _____ V



0 7 . 3 The input pd causes an alternating current.

Explain why there is an alternating current in the output when the transformer is connected to a circuit.

[3 marks]

Question 7 continues on the next page

Turn over ►



Figure 13 shows a large cable supported by two wooden poles. The cable is connected to an electricity supply.

*Do not write
outside the
box*

Figure 13

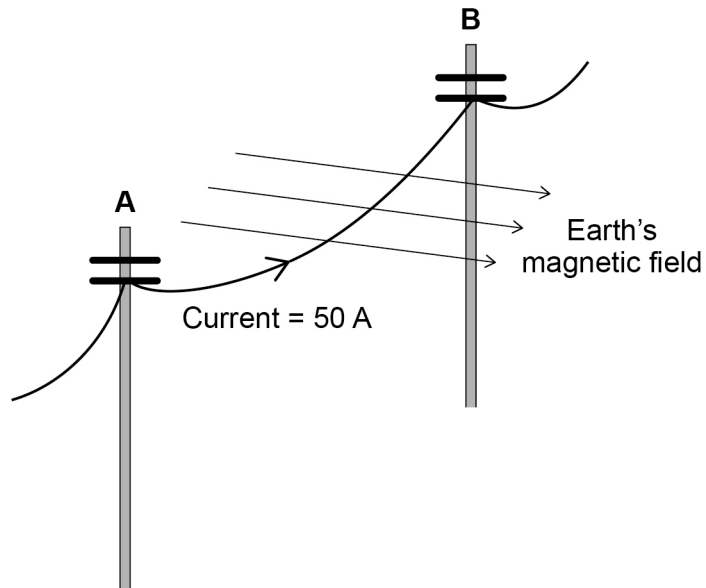

0 7 . 4

There is a force on the cable due to the Earth's magnetic field when the current is in the direction **A** to **B**.

What is the direction of this force?

[1 mark]

Tick (✓) **one** box.

Down

Left

Right

Up



0 7 . 5 The cable experiences a force of 0.045 N due to the Earth's magnetic field.

magnetic flux density = $60 \mu\text{T}$

current = 50 A

Calculate the length of the cable between **A** and **B**.

Use the Physics Equations Sheet.

[4 marks]

Length = _____ m

0 7 . 6 State **one** assumption you made in your calculation.

[1 mark]

14

Turn over for the next question

Turn over ►



0 8

Diving bricks sink to the bottom of a swimming pool.

Figure 14 shows a diving brick.

Figure 14

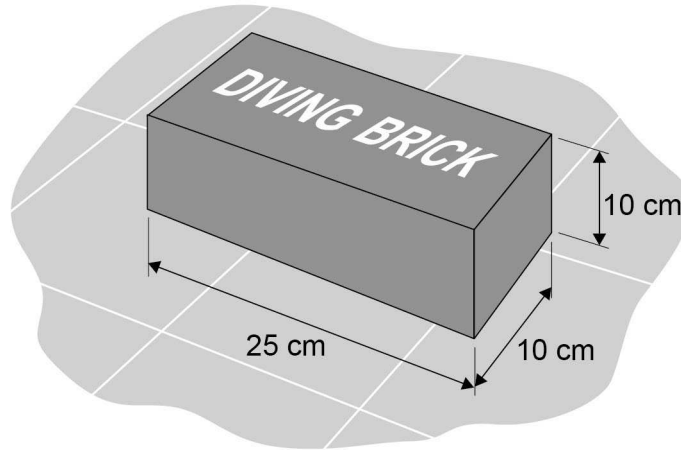

Swimmers practise diving to the bottom of the swimming pool to pick up the diving brick.

0 8 . 1

Explain why the forces on the brick at the bottom of the pool cause the brick to be stationary.

[3 marks]



08.2

When the brick from **Figure 14** is at the bottom of the pool, the top surface of the brick is 2.50 m below the surface of the water.

The force acting on the top surface of the brick due to the weight of the water is 637 N.

gravitational field strength = 9.8 N/kg

Calculate the density of the water in the swimming pool.

Use the Physics Equations Sheet.

[6 marks]

Density of water = _____ kg/m³

Question 8 continues on the next page

Turn over ►



08.3

Professional divers are trained in a very deep swimming pool.

The density of the water in this pool is **not** the same as the density of the water in Question **08.2**

The diving brick was dropped into the very deep swimming pool.

When the brick was at a depth of 2.50 m, the force due to the weight of the water on the top surface of the brick was 618 N.

Figure 15 shows the diving brick at the bottom of the very deep swimming pool.

Figure 15

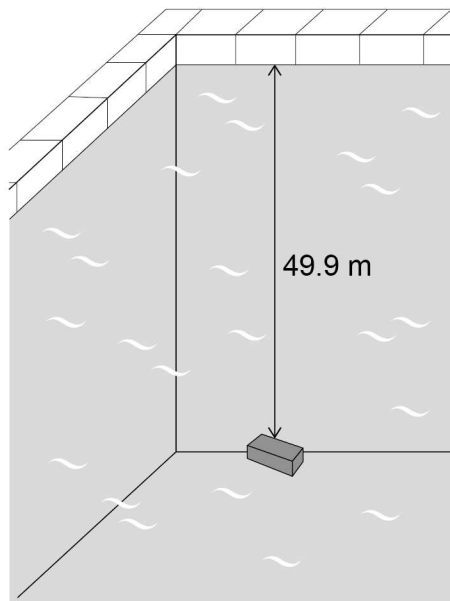

Determine the force due to the weight of the water on the top surface of the brick in **Figure 15**.

Use the Physics Equations Sheet.

Give your answer to 3 significant figures.

[3 marks]

Force (3 significant figures) = _____ N

*Do not write
outside the
box*

12

END OF QUESTIONS



There are no questions printed on this page

*Do not write
outside the
box*

**DO NOT WRITE ON THIS PAGE
ANSWER IN THE SPACES PROVIDED**



Do not write
outside the
box

Question number	Additional page, if required. Write the question numbers in the left-hand margin.



*Do not write
outside the
box*

Question number	Additional page, if required. Write the question numbers in the left-hand margin.

Do not write
outside the
box

Question number	<p style="text-align: center;">Additional page, if required. Write the question numbers in the left-hand margin.</p>
	<hr/> <hr/> <hr/> <hr/> <hr/> <hr/> <hr/> <hr/> <hr/> <hr/> <hr/> <hr/> <hr/> <hr/> <hr/> <hr/> <hr/> <hr/> <hr/> <hr/> <hr/> <hr/> <hr/> <hr/> <hr/>
	<p>Copyright information</p> <p>For confidentiality purposes, all acknowledgements of third-party copyright material are published in a separate booklet. This booklet is published after each live examination series and is available for free download from www.aqa.org.uk.</p> <p>Permission to reproduce all copyright material has been applied for. In some cases, efforts to contact copyright-holders may have been unsuccessful and AQA will be happy to rectify any omissions of acknowledgements. If you have any queries please contact the Copyright Team.</p> <p>Copyright © 2022 AQA and its licensors. All rights reserved.</p>

