

Please write clearly in block capitals.

Centre number

Candidate number

Surname _____

Forename(s) _____

Candidate signature _____

A-level PHYSICS

Paper 1

Monday 4 June 2018

Afternoon

Time allowed: 2 hours

Materials

For this paper you must have:

- a pencil and a ruler
- a scientific calculator
- a Data and Formulae Booklet.

Instructions

- Use black ink or black ball-point pen.
- Fill in the boxes at the top of this page.
- Answer **all** questions.
- You must answer the questions in the spaces provided. Do not write outside the box around each page or on blank pages.
- Do all rough work in this book. Cross through any work you do not want to be marked.
- Show all your working.

Information

- The marks for questions are shown in brackets.
- The maximum mark for this paper is 85.
- You are expected to use a scientific calculator where appropriate.
- A Data and Formulae Booklet is provided as a loose insert.

For Examiner's Use	
Question	Mark
1	
2	
3	
4	
5	
6	
7–31	
TOTAL	



Section AAnswer **all** questions in this section.**0 1**

Horizontal escape lanes made of loose gravel have been constructed at the side of some roads on steep hills so that vehicles can stop safely when their brakes fail.

Figure 1 shows an engineer's prediction of how the speed of an unpowered vehicle of mass 1.8×10^4 kg will vary with time as the vehicle comes to rest in an escape lane.

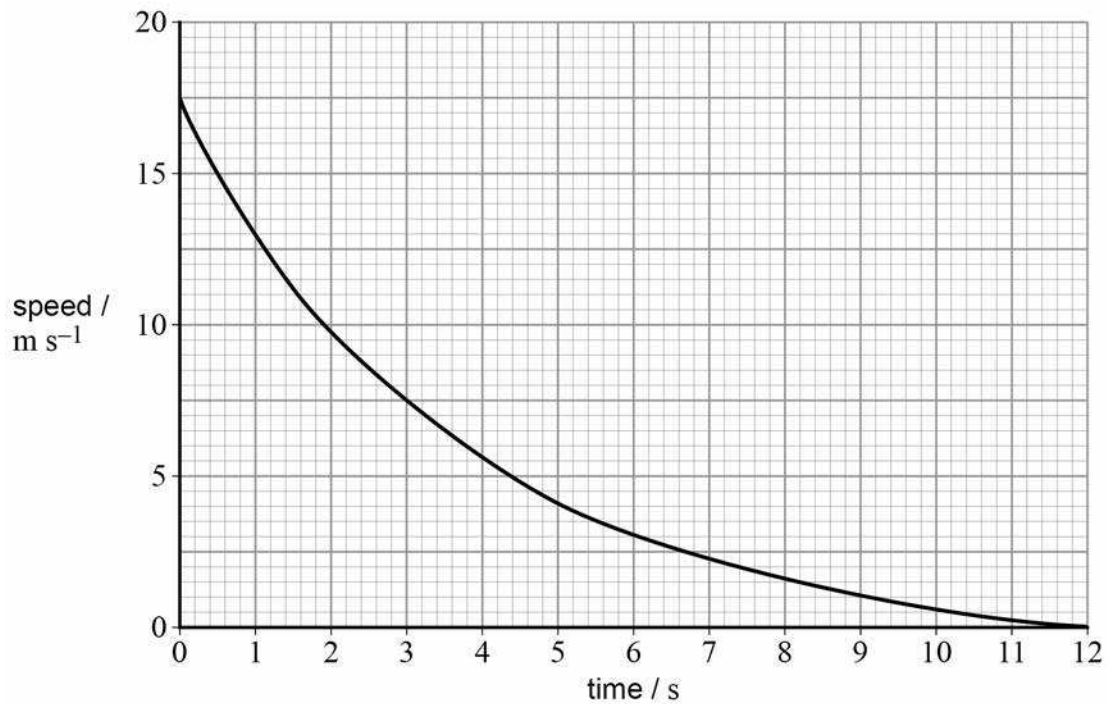
Figure 1**0 1 . 1**

Determine the force decelerating the vehicle 2.0 s after entering the escape lane.

[3 marks]

force decelerating the vehicle = _____ N



0 1 . 2

Deduce whether a lane of length 85 m is long enough to stop the vehicle, assuming that the engineer's graph is correct.

[3 marks]

0 1 . 3

Discuss the energy transfers that take place when a vehicle is decelerated in an escape lane.

[2 marks]

Question 1 continues on the next page

Turn over ►

0 1 . 4

An alternative to an escape lane containing gravel is an escape lane that consists of a ramp. An escape ramp is a straight road with a concrete surface that has a constant upward gradient.

One escape ramp makes an angle of 25° to the horizontal and is 85 m long.

Deduce whether this escape ramp is sufficient to stop the vehicle.

Assume that any frictional forces and air resistance that decelerate the vehicle are negligible.

[3 marks]

0 1 . 5

Discuss whether an escape lane containing gravel or an escape ramp would provide the safer experience for the driver of the vehicle as it comes to rest.

[1 mark]

12

0 2

Table 1 shows results of an experiment to investigate how the de Broglie wavelength λ of an electron varies with its velocity v .

Table 1

$v / 10^7 \text{ m s}^{-1}$	$\lambda / 10^{-11} \text{ m}$
1.5	4.9
2.5	2.9
3.5	2.1

0 2 . 1

Show that the data in **Table 1** are consistent with the relationship $\lambda \propto \frac{1}{v}$

[2 marks]

0 2 . 2

Calculate a value for the Planck constant suggested by the data in **Table 1**.

[2 marks]

Planck constant = _____ J s

Question 2 continues on the next page

Turn over ►



0 2 . 3

Figure 2 shows the side view of an electron diffraction tube used to demonstrate the wave properties of an electron.

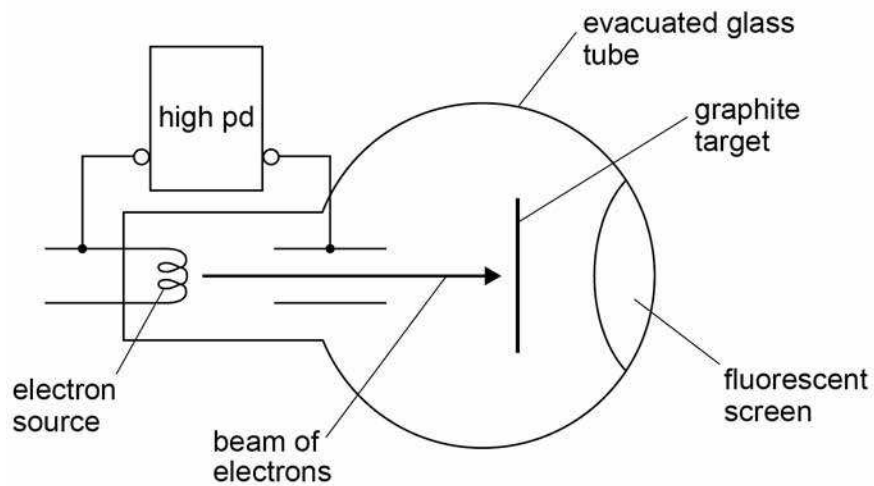
Figure 2**Side view**

An electron beam is incident on a thin graphite target that behaves like the slits in a diffraction grating experiment. After passing through the graphite target the electrons strike a fluorescent screen.

Figure 3 shows the appearance of the fluorescent screen when the electrons are incident on it.

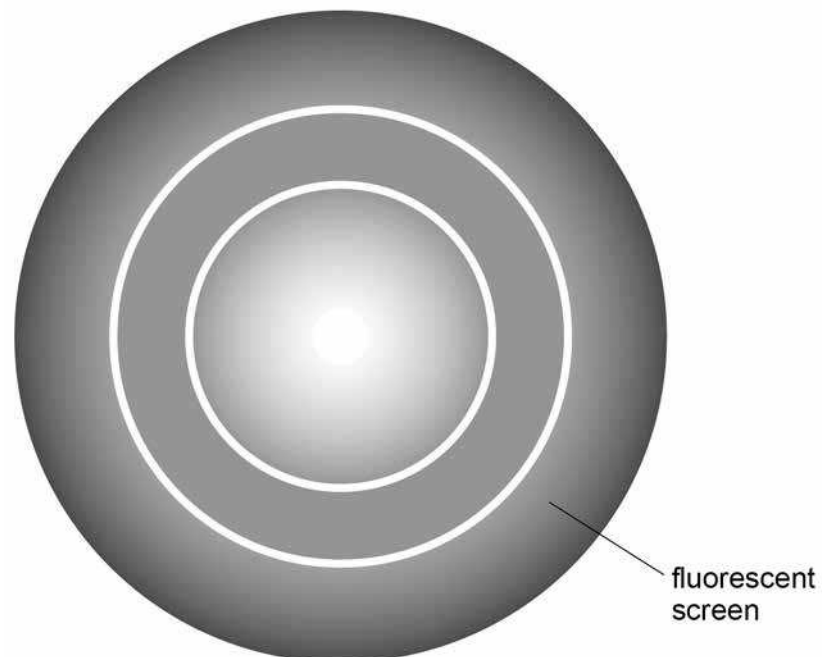
Figure 3**Front view**

Explain how the pattern produced on the screen supports the idea that the electron beam is behaving as a wave rather than as a stream of particles.

[3 marks]

0 2 . 4

Explain how the emission of light from the fluorescent screen shows that the electrons incident on it are behaving as particles.

[3 marks]

10

Turn over ►



0 3

Figure 4 shows the structure of a violin and **Figure 5** shows a close-up image of the tuning pegs.

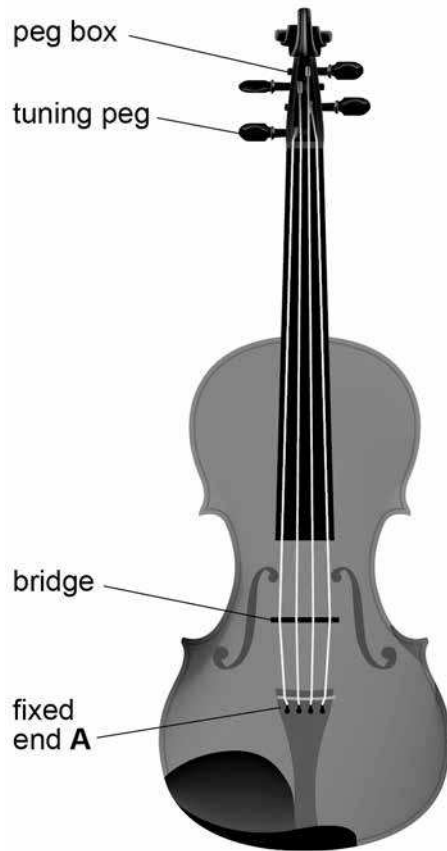
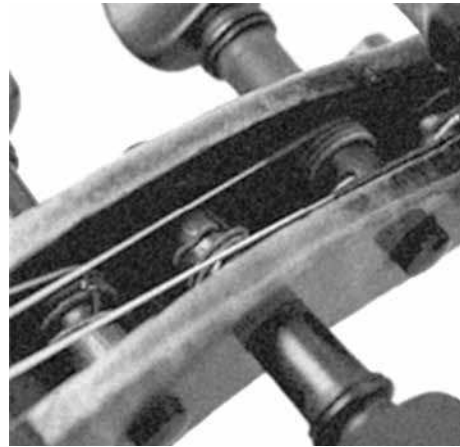
Figure 4**Figure 5**

The strings are fixed at end **A**. The strings pass over a bridge and the other ends of the strings are wound around tuning pegs that have a circular cross-section. The tension in the strings can be increased or decreased by rotating the tuning pegs.



0 3 . 1

Explain how a stationary wave is produced when a stretched string is plucked.

[3 marks]

0 3 . 2

The vibrating length of one of the strings of a violin is 0.33 m
When the tension in the string is 25 N, the string vibrates with a first-harmonic
frequency of 370 Hz

Show that the mass of a 1.0 m length of the string is about 4×10^{-4} kg**[2 marks]****0 3 . 3**

Determine the speed at which waves travel along the string in question 03.2 when it vibrates with a first-harmonic frequency of 370 Hz

[1 mark]speed of waves = _____ m s^{-1} **Question 3 continues on the next page****Turn over ►**

0 3 . 4

Figure 6 shows how the tension in the string in question **03.2** varies with the extension of the string.

Figure 6

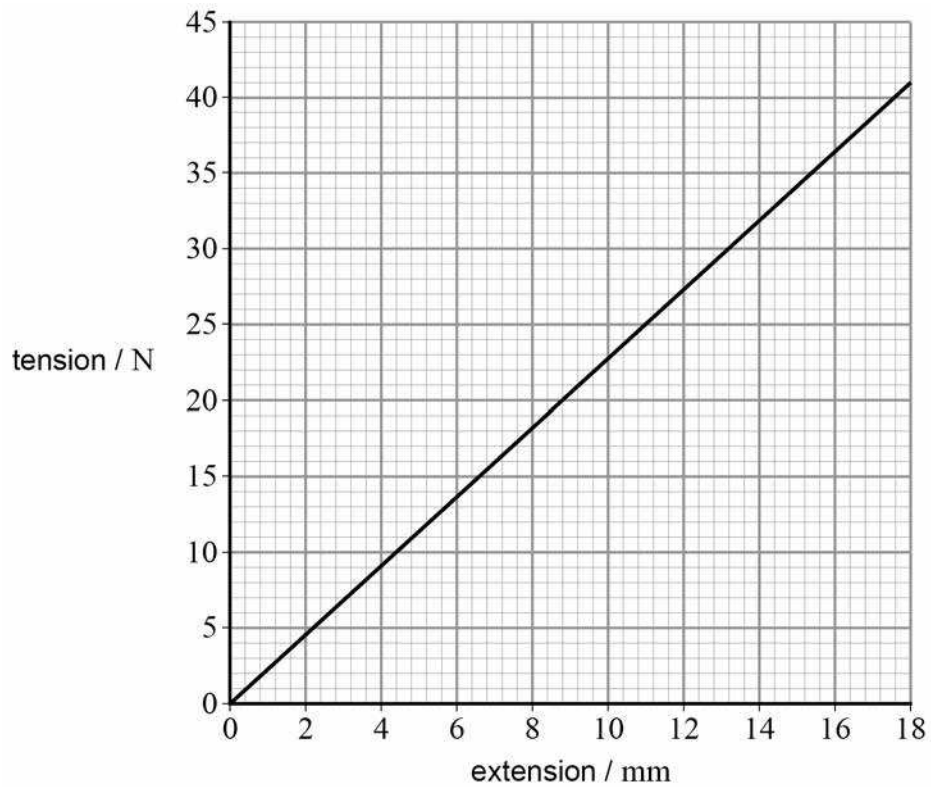

The string with its initial tension of 25 N is vibrating at a frequency of 370 Hz
The diameter of the circular peg is 7.02 mm



Determine the higher frequency that is produced when the string is stretched by rotating the tuning peg through an angle of 75°

Assume that there is no change in the diameter of the string.

[4 marks]

frequency = _____ Hz

10

Turn over for the next question

Turn over ►



0 4

Figure 7 shows a circuit designed by a student to monitor temperature changes.

Figure 7

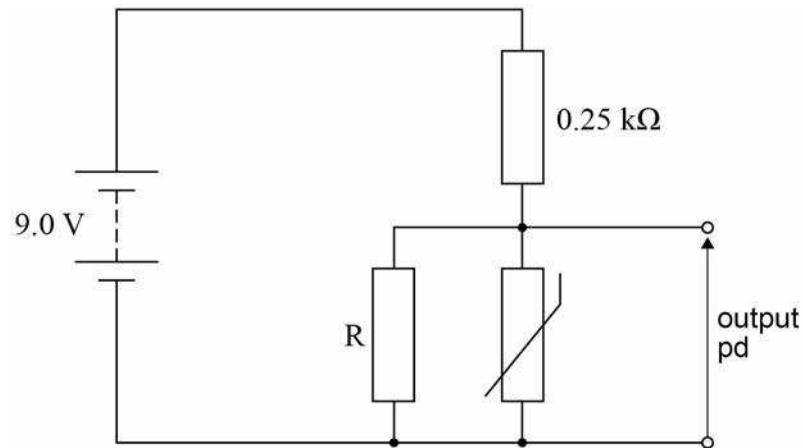

The supply has negligible internal resistance and the thermistor has a resistance of 750Ω at room temperature. The student wants the output potential difference (pd) at room temperature to be 5.0 V

0 4 . 1

The $0.25 \text{ k}\Omega$ resistor is made of 50 turns of wire that is wound around a non-conducting cylinder of diameter 8.0 mm

$$\text{Resistivity of the wire} = 4.2 \times 10^{-7} \Omega \text{ m}$$

Determine the area of cross-section of the wire that has been used for the resistor.

[3 marks]

area of cross-section = _____ m^2



0 4 . 2 The student selects a resistor rated at 0.36 W for the 0.25 k Ω resistor in **Figure 7**.

Determine whether this resistor is suitable.

[2 marks]

0 4 . 3 Determine the value of R that the student should select.

Give your answer to an appropriate number of significant figures.

[5 marks]

value of R = _____ Ω

Question 4 continues on the next page

Turn over ►



0	4	.	4
---	---	---	---

State and explain the effect on the output pd of increasing the temperature of the thermistor.

[2 marks]

12



Turn over for the next question

**DO NOT WRITE ON THIS PAGE
ANSWER IN THE SPACES PROVIDED**

Turn over ►



0 5

Figure 8 shows a side view of an act performed by two acrobats. **Figure 9** shows the view from above.

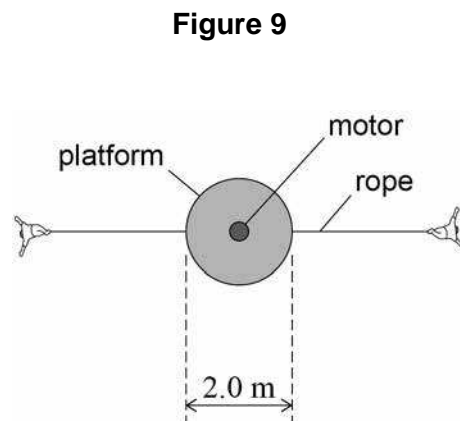
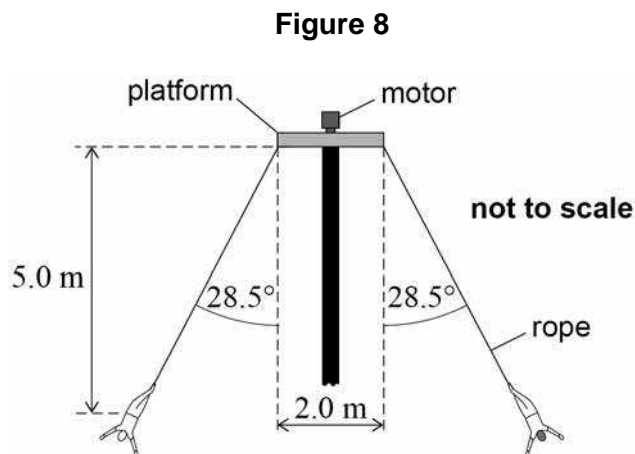

The acrobats, each of mass 85 kg, are suspended from ropes attached to opposite edges of a circular platform that is at the top of a vertical pole. The platform has a diameter of 2.0 m

A motor rotates the platform so that the acrobats move at a constant speed in a horizontal circle, on opposite sides of the pole.

When the period of rotation of the platform is 5.2 s, the centre of mass of each acrobat is 5.0 m below the platform and the ropes are at an angle of 28.5° to the vertical as shown in **Figure 8**.

0 5 . 1

Show that the linear speed of the acrobats is about 4.5 m s^{-1}

[2 marks]



0 6

Figure 10 shows two railway trucks **A** and **B** travelling towards each other on the same railway line which is straight and horizontal.

Figure 10

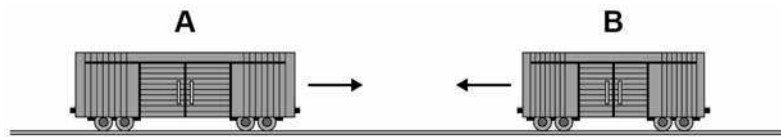

The trucks are involved in an inelastic collision. They join when they collide and then move together.

The trucks move a distance of 15 m before coming to rest.

Truck **A** has a total mass of 16 000 kg and truck **B** has a total mass of 12 000 kg

Just before the collision, truck **A** was moving at a speed of 2.8 m s^{-1} and truck **B** was moving at a speed of 3.1 m s^{-1}

0 6 . 1

State the quantity that is **not** conserved in an inelastic collision.

[1 mark]

0 6 . 2

Show that the speed of the joined trucks immediately after the collision is about 0.3 m s^{-1}

[3 marks]



0 6 . 3

Calculate the impulse that acts on each truck during the collision.
Give an appropriate unit for your answer.

[2 marks]

impulse = _____ unit _____

0 6 . 4

Explain, without doing a calculation, how the motion of the trucks immediately after the collision would be different for a collision that is perfectly elastic.

[2 marks]

8**Turn over ►**

Section B

Each of Questions **07** to **31** is followed by four responses, **A**, **B**, **C** and **D**.

For each question select the best response.

Only **one** answer per question is allowed.

For each answer completely fill in the circle alongside the appropriate answer.

CORRECT METHOD



WRONG METHODS



If you want to change your answer you must cross out your original answer as shown. 

If you wish to return to an answer previously crossed out, ring the answer you now wish to select as shown. 

You may do your working in the blank space around each question but this will not be marked.
Do **not** use additional sheets for this working.

0 7

What is a correct unit for the area under a force–time graph?

[1 mark]

A N m

B kg m s⁻¹

C kg m s⁻²

D N s⁻¹

0 8

A student carries out an experiment to determine the resistivity of a metal wire. She determines the resistance from measurements of potential difference between the ends of the wire and the corresponding current. She measures the length of the wire with a ruler and the diameter of the wire using a micrometer. Each measurement is made with an uncertainty of 1%

Which measurement gives the largest uncertainty in the calculated value of the resistivity?

[1 mark]

A current

B diameter

C length

D potential difference



0 9 Fluoride ions are produced by the addition of a single electron to an atom of fluorine ${}^{19}_9\text{F}$.

What is the magnitude of specific charge of the fluoride ion?

[1 mark]

- A** $3.2 \times 10^{-26} \text{ C kg}^{-1}$
- B** $8.4 \times 10^{-21} \text{ C kg}^{-1}$
- C** $5.0 \times 10^6 \text{ C kg}^{-1}$
- D** $4.5 \times 10^7 \text{ C kg}^{-1}$

1 0 Two gamma photons are produced when a muon and an antimuon annihilate each other.

What is the minimum frequency of the gamma radiation that could be produced?

[1 mark]

- A** $2.55 \times 10^{16} \text{ Hz}$
- B** $5.10 \times 10^{16} \text{ Hz}$
- C** $2.55 \times 10^{22} \text{ Hz}$
- D** $5.10 \times 10^{22} \text{ Hz}$

1 1 The Σ^0 baryon, composed of the quark combination uds , is produced through the strong interaction between a π^+ meson and a neutron.

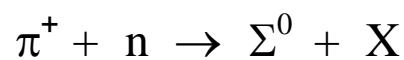

What is the quark composition of X ?

[1 mark]

- A** $u\bar{s}$
- B** ud
- C** $u\bar{d}$
- D** $ud\bar{s}$

Turn over ►



- 1 2** An iodine nucleus decays into a nucleus of Xe-131, a beta-minus particle and particle Y.



Which is a property of particle Y?

[1 mark]

- A** It has a lepton number of +1
- B** It is an antiparticle
- C** It is negatively charged
- D** It experiences the strong interaction

- 1 3** The diagram shows an energy-level diagram for a hydrogen atom.

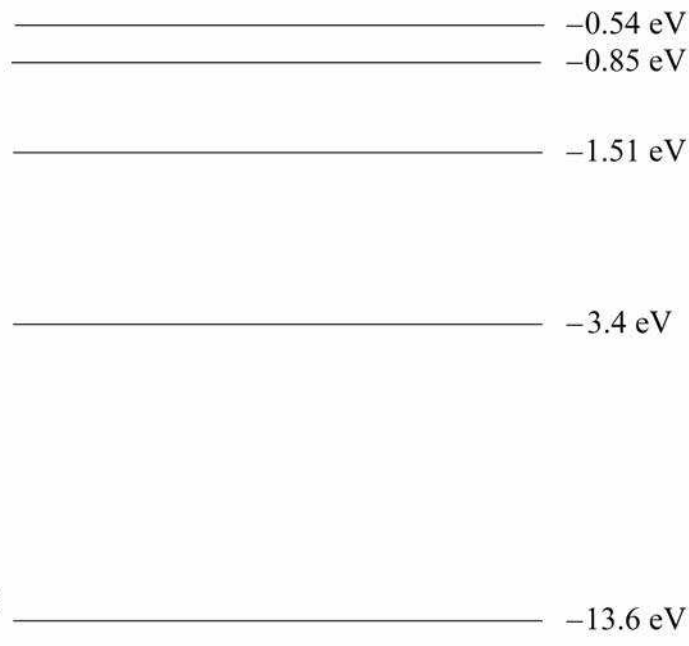

Electrons, each having a kinetic energy of 2.0×10^{-18} J, collide with atoms of hydrogen in their ground state. Photons are emitted when the atoms de-excite.

How many different wavelengths can be observed with incident electrons of this energy?

[1 mark]

- A** 1
- B** 3
- C** 6
- D** 7



1 4

Photons of wavelength 290 nm are incident on a metal plate. The work function of the metal is 4.1 eV

What is the maximum kinetic energy of the emitted electrons?

[1 mark]

A 0.19 eV

B 4.3 eV

C 6.9 eV

D 8.4 eV

1 5

In the diagram, P is the source of a wave of frequency 50 Hz

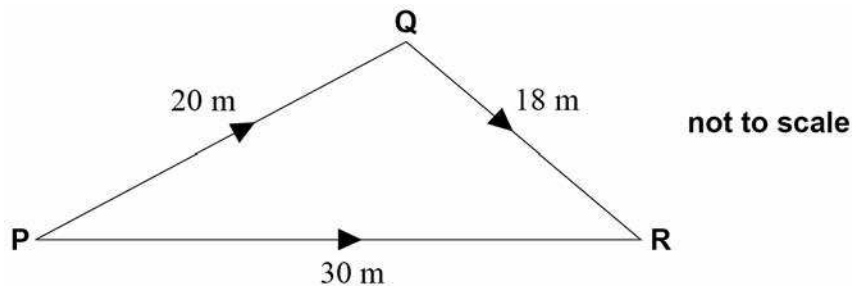

The wave travels to R by two routes, $P \rightarrow Q \rightarrow R$ and $P \rightarrow R$. The speed of the wave is 30 m s^{-1}

What is the path difference between the two waves at R in terms of the wavelength λ of the waves?

[1 mark]

A 4.8λ

B 8.0λ

C 13.3λ

D 20.0λ

Turn over ►



1 6

Light from a point source passes through a single slit and is then incident on a double-slit arrangement. An interference pattern is observed on the screen.

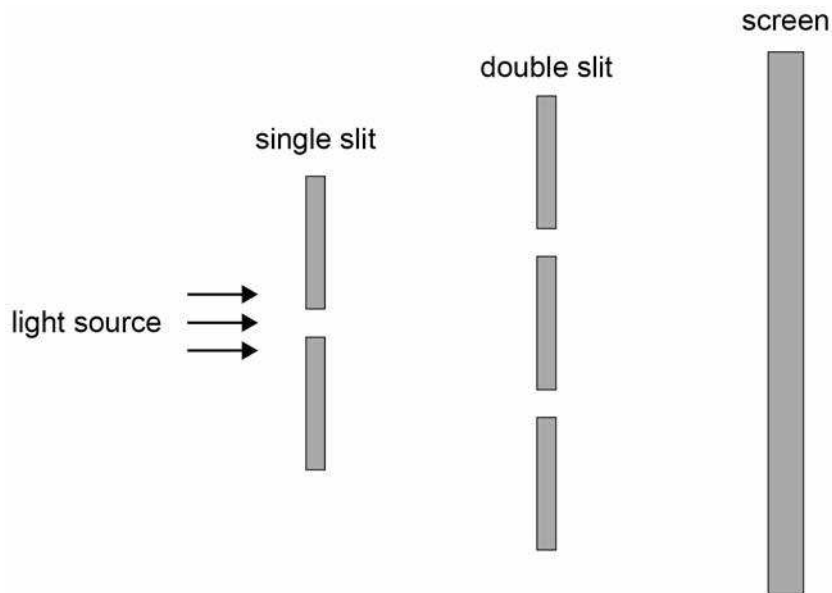

What will increase the fringe spacing?

[1 mark]

- A** increasing the separation of the single slit and the double slit
- B** increasing the width of the single slit
- C** decreasing the distance between the double slits and the screen
- D** decreasing the separation of the double slits

1 7

A diffraction grating has 500 lines per mm. When monochromatic light is incident normally on the grating the third-order spectral line is formed at an angle of 60° from the normal to the grating.

What is the wavelength of the monochromatic light?

[1 mark]

- A** 220 nm
- B** 580 nm
- C** 960 nm
- D** 1700 nm



1 8

An electromagnetic wave enters a fibre-optic cable from air. On entering the cable, the wave slows down to three-fifths of its original speed.

What is the refractive index of the core of the fibre-optic cable?

[1 mark]

A 0.67

B 1.33

C 1.50

D 1.67

Turn over for the next question

Turn over ►

1 9 The diagram shows part of the path of a ray of light through a right-angled prism.

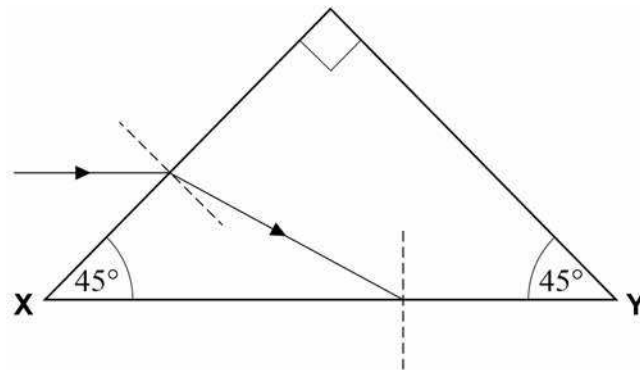

The prism is made of glass of refractive index 1.5
The incident light ray is parallel to the face **XY**. The ray is refracted towards the face **XY**.

What is the path of the ray after it is incident on face **XY**?

[1 mark]

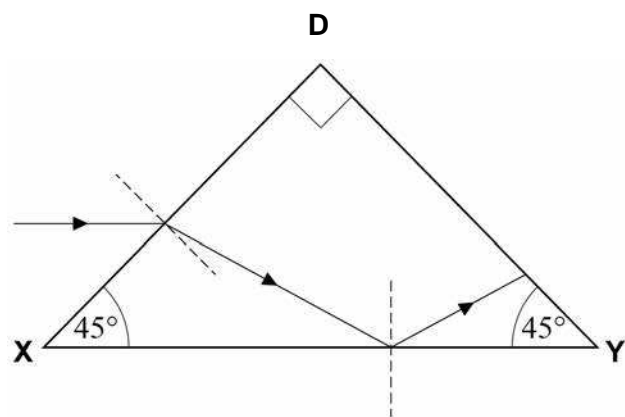
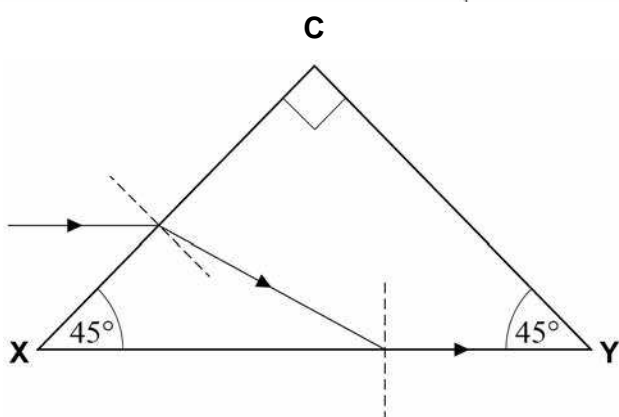
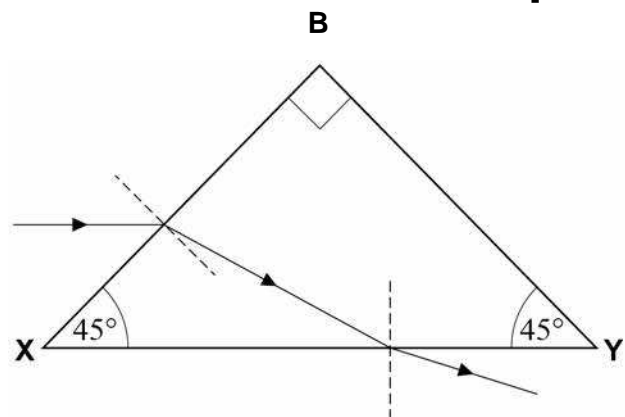
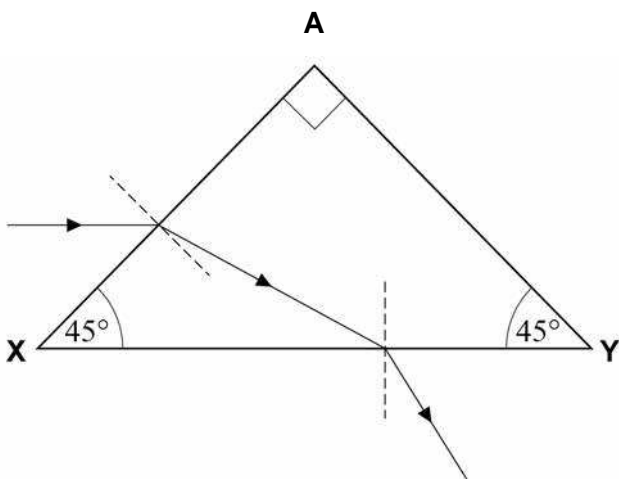

- A**
- B**
- C**
- D**



2 0 Three coplanar forces F_1 , F_2 and F_3 act on a point object.

Which combination of forces can never produce a resultant force of zero?

[1 mark]

	F_1 / N	F_2 / N	F_3 / N	
A	3	4	5	<input type="checkbox"/>
B	8	8	8	<input type="checkbox"/>
C	2	10	10	<input type="checkbox"/>
D	3	6	10	<input type="checkbox"/>

2 1 A non-uniform sign is 0.80 m long and has a weight of 18 N. It is suspended from two vertical springs **P** and **Q**. The springs obey Hooke's law and the spring constant of each spring is 240 N m^{-1} .

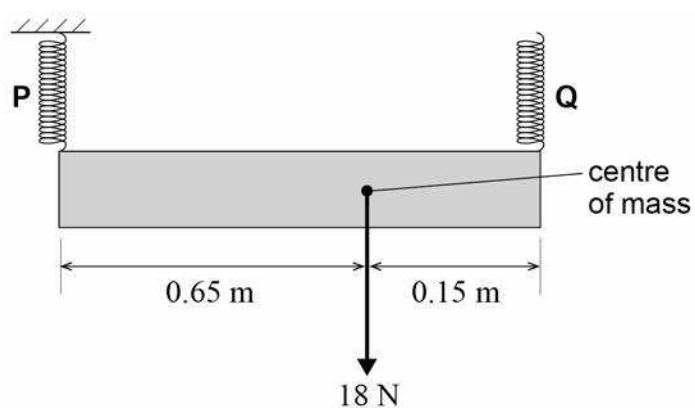

The top end of spring **P** is fixed and the top end of spring **Q** is adjusted until the sign is horizontal and in equilibrium.

What is the extension of spring **Q**?

[1 mark]

- A** 0.014 m
- B** 0.038 m
- C** 0.049 m
- D** 0.061 m

Turn over ►



2 2

Immediately after take-off from the surface of the Earth, a rocket of mass 12 000 kg accelerates vertically upwards at 1.4 m s^{-2}

What is the thrust produced by the rocket motor?

[1 mark]**A** $1.7 \times 10^4 \text{ N}$ **B** $1.0 \times 10^5 \text{ N}$ **C** $1.3 \times 10^5 \text{ N}$ **D** $1.6 \times 10^5 \text{ N}$ **2 3**

A projectile is launched with a speed of 25 m s^{-1} at an angle of 35° to the horizontal, as shown in the diagram.

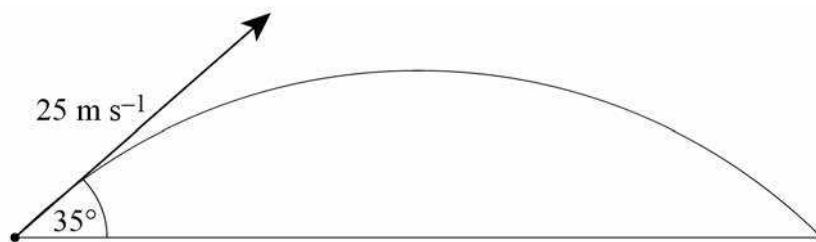

Air resistance is negligible.

What is the time taken for the projectile to return to the ground?

[1 mark]**A** 1.5 s**B** 2.1 s**C** 2.9 s**D** 4.2 s

2 4

A steel wire **W** has a length l and a circular cross-section of radius r . When **W** hangs vertically and a load is attached to the bottom end, it extends by e . Another wire **X** made from the same material has the same load attached to it.

Which length and radius for **X** will produce an extension of $\frac{e}{4}$?

[1 mark]

	Length of X	Radius of X	
A	$0.5l$	$2r$	<input type="checkbox"/>
B	l	$4r$	<input type="checkbox"/>
C	$2l$	$2r$	<input type="checkbox"/>
D	$4l$	$4r$	<input type="checkbox"/>

2 5

A gas containing doubly-charged ions flows to give an electric current of 0.64 A

How many ions pass a point in 1.0 minute?

[1 mark]

A 2.0×10^{18}

B 4.0×10^{18}

C 1.2×10^{20}

D 2.4×10^{20}

2 6

A mobile phone operates at a constant power of 200 mW

It has a 3.7 V lithium-ion battery that has a charge capacity of 9400 C

What is the time taken for the battery to discharge completely?

[1 mark]

A 2 hours

B 48 hours

C 120 hours

D 140 hours

Turn over ►

- 2 7** The two resistors shown are both uniform cylinders of equal length made from the same conducting putty.

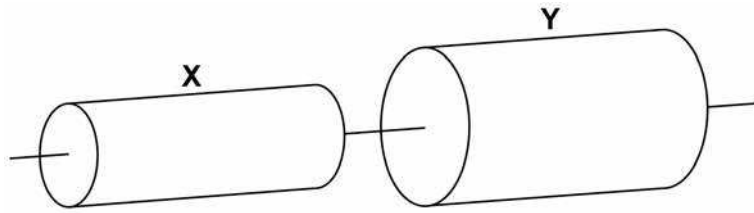

The diameter of **Y** is twice that of **X**. The resistance of **Y** is R .

What is the total resistance of the combination?

[1 mark]

- A** $\frac{4R}{5}$
B $3R$
C $4R$
D $5R$

- 2 8** A voltmeter is used to measure potential difference for a component **X**.

Which row gives the position and ideal resistance for the voltmeter?

[1 mark]

	Position	Ideal resistance	
A	in series with X	infinite	<input type="checkbox"/>
B	in series with X	zero	<input type="checkbox"/>
C	in parallel with X	infinite	<input type="checkbox"/>
D	in parallel with X	zero	<input type="checkbox"/>



2 9

A body performs simple harmonic motion.

What is the phase difference between the variation of displacement with time and the variation of acceleration with time for the body?

[1 mark]**A** 0**B** $\frac{\pi}{4}$ rad**C** $\frac{\pi}{2}$ rad**D** π rad**3 0**

An object of mass 0.15 kg performs simple harmonic motion. It oscillates with amplitude 55 mm and frequency 0.80 Hz

What is the maximum value of its kinetic energy?

[1 mark]**A** 5.7×10^{-3} J**B** 11×10^{-3} J**C** 0.57 J**D** 11 J

Turn over for the next question

Turn over ►

3 1

Which graph shows how the gravitational potential energy E_p of a simple pendulum varies with displacement s from the equilibrium position?

[1 mark]

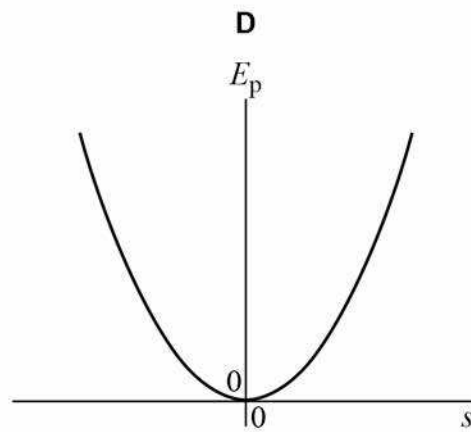
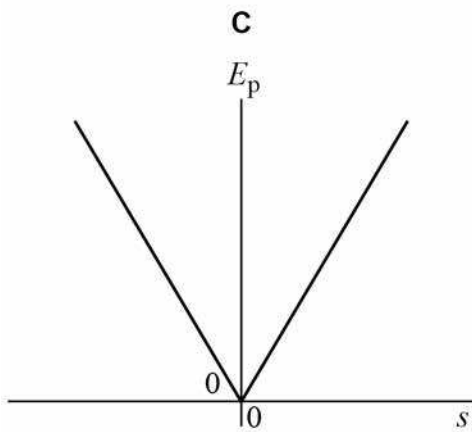
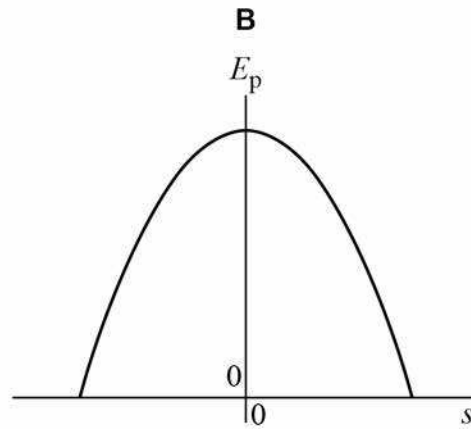
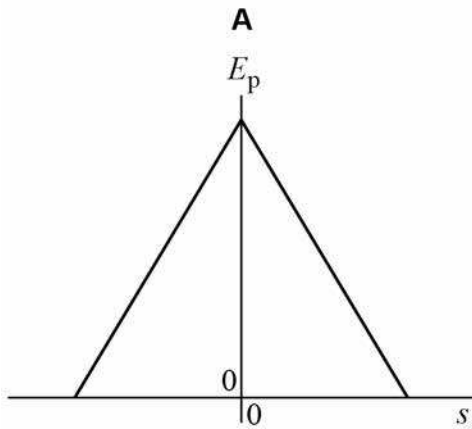
A B C D **END OF QUESTIONS****Copyright information**

For confidentiality purposes, from the November 2015 examination series, acknowledgements of third party copyright material will be published in a separate booklet rather than including them on the examination paper or support materials. This booklet is published after each examination series and is available for free download from www.aqa.org.uk after the live examination series.

Permission to reproduce all copyright material has been applied for. In some cases, efforts to contact copyright-holders may have been unsuccessful and AQA will be happy to rectify any omissions of acknowledgements. If you have any queries please contact the Copyright Team, AQA, Stag Hill House, Guildford, GU2 7XJ.

Copyright © 2018 AQA and its licensors. All rights reserved.

