

Please write clearly in block capitals.

Centre number

Candidate number

Surname _____

Forename(s) _____

Candidate signature _____

GCSE MATHEMATICS

F

Foundation Tier Paper 1 Non-Calculator

Tuesday 5 November 2019

Morning

Time allowed: 1 hour 30 minutes

Materials

For this paper you must have:

- mathematical instruments

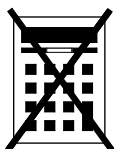

You must **not** use a calculator.

Instructions

- Use black ink or black ball-point pen. Draw diagrams in pencil.
- Fill in the boxes at the top of this page.
- Answer **all** questions.
- You must answer the questions in the spaces provided. Do not write outside the box around each page or on blank pages.
- Do all rough work in this book. Cross through any work you do not want to be marked.

Information

- The marks for questions are shown in brackets.
- The maximum mark for this paper is 80.
- You may ask for more answer paper, graph paper and tracing paper. These must be tagged securely to this answer book.

For Examiner's Use	
Pages	Mark
2–3	
4–5	
6–7	
8–9	
10–11	
12–13	
14–15	
16–17	
18–19	
20–21	
22–23	
24–25	
26	
TOTAL	

Advice

In all calculations, show clearly how you work out your answer.



Answer **all** questions in the spaces provided

Do not write
outside the
box

- 1 Circle the value of the digit 9 in the number 7.962

[1 mark]

$$\frac{9}{1000}$$

$$\frac{9}{100}$$

$$\frac{9}{10}$$

9

- 2 Solve $3x = 6$

Circle your answer.

[1 mark]

$$x = 0.5$$

$$x = 2$$

$$x = 3$$

$$x = 18$$

- 3 Circle the correct statement.

[1 mark]

$$0.3 > \frac{1}{4}$$

$$0.3 = \frac{1}{4}$$

$$0.3 \leq \frac{1}{4}$$

$$0.3 < \frac{1}{4}$$



4 Circle the number that is closest in value to $\sqrt{50}$

[1 mark]

5

7

8

25

5 Work out 76×24

[3 marks]

Answer _____

7

Turn over ►



- 6 The composite bar chart shows the number of students in some classes.

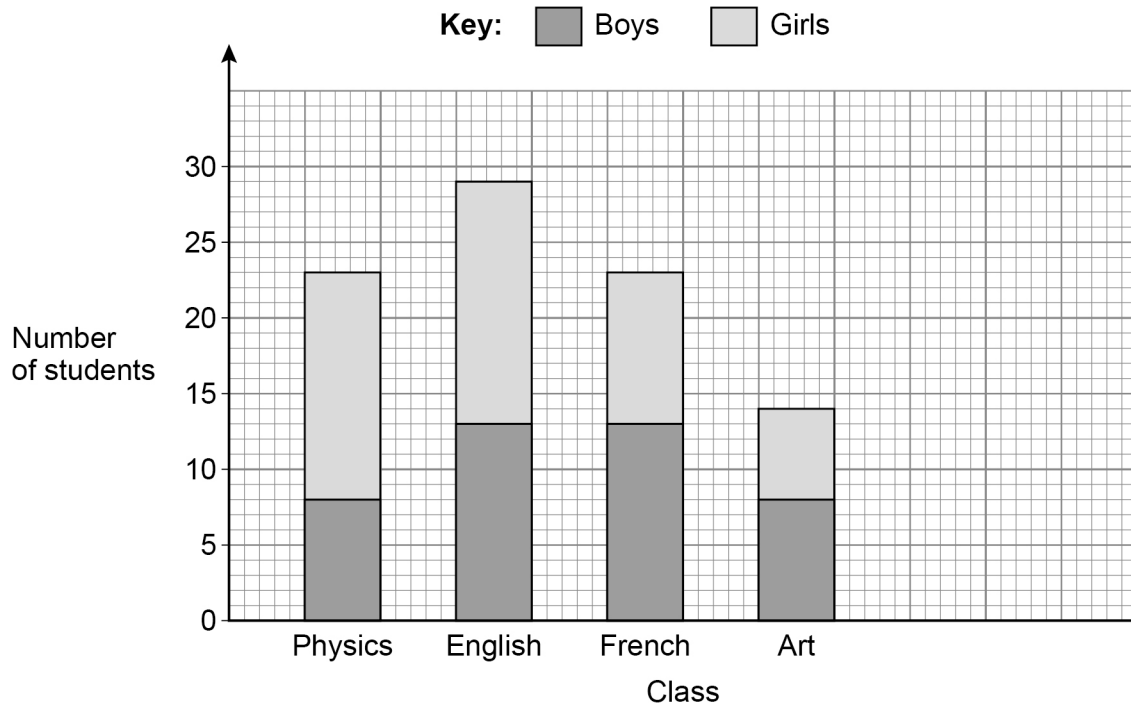

- 6 (a) How many boys are in the Physics class?

[1 mark]

Answer _____

- 6 (b) How many girls are in the English class?

[1 mark]

Answer _____

- 6 (c) Which **two** classes have the same total number of students?

[1 mark]

Answer _____ and _____



- 6 (d)** In the History class
there are 18 students
number of boys = number of girls

Show this information on the bar chart.

[2 marks]

- 7 (a)** Work out $1.86 \div 6$

[1 mark]

Answer _____

- 7 (b)** Work out 0.4×0.2

[1 mark]

Answer _____



8 Here are four number cards.

8.6

0.27

6.3

0.4

8 (a) Choose **two** of the cards to make the answer to this calculation a whole number.
Include the answer to the calculation.

[2 marks]

$$\boxed{} + \boxed{} = \underline{\hspace{2cm}}$$

8 (b) Choose **two** of the cards to make the answer to this calculation as large as possible.
Include the answer to the calculation.

[2 marks]

$$\boxed{} - \boxed{} = \underline{\hspace{2cm}}$$



9

Rulers
85p each

Pens
£3.50 each

Jenny buys 5 rulers and 2 pens.
She works out how much she should pay.

$$\begin{aligned}5 \times 85p &= \text{£}4.25 \\2 \times \text{£}3.50 &= \text{£}6.10 \\ \text{Total} &= \text{£}10.35\end{aligned}$$

Jenny's total is wrong.

What mistake has she made?

Include the correct total in your answer.

[2 marks]

Mistake made _____

Correct total £ _____

Turn over for the next question



10 Here are three calculations, A, B and C.

A

$$100 \times 20\,000$$

B

$$1 \text{ million} \div 2$$

C

$$4 \times 100\,000$$

Put the calculations in order.

Start with the calculation that has the smallest answer.

You **must** show the answer to each calculation.

[3 marks]

Smallest _____

Largest _____



- 11** In a raffle, 200 tickets are sold.
The tickets are either red or blue.
The winning ticket is picked at random.

- 11 (a)** What is the probability that the winning ticket is green?

[1 mark]

Answer _____

- 11 (b)** 79 children and 90 women buy one ticket each.
Men buy the rest of the tickets.
Work out the probability that a man buys the winning ticket.

[2 marks]

Answer _____

Turn over for the next question



- 12** A college has
a total of 105 teachers
19 more female teachers than male teachers.

What proportion of the teachers are female?

[3 marks]

Answer _____

- 13** By rounding each number to the nearest 10, estimate the value of $262 \div 19.8$

[2 marks]

Answer _____



14

 $ABEF$ and $ACDF$ are rectangles.

$AF = 10 \text{ cm}$

$AB = 2 \text{ cm}$

$BC = 4 \text{ cm}$

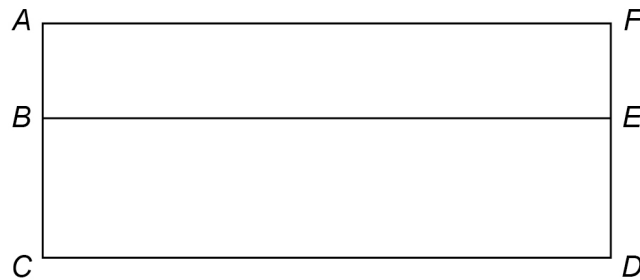
Not drawn
accurately

Work out

perimeter $ABEF$: perimeter $ACDF$

Give your answer in its simplest form.

[3 marks]

Answer _____ : _____

Turn over for the next question**Turn over ►**

- 15 ADB and CD are straight lines.

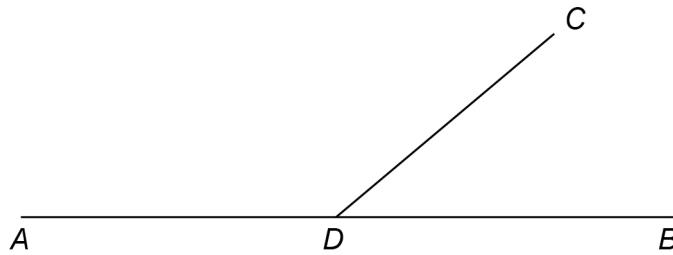

Not drawn
accurately

$$\text{angle } ADC = 5 \times \text{angle } CDB$$

Work out the size of angle ADC .

[3 marks]

Answer _____ degrees

- 16 Circle the value of 5^3

[1 mark]

8

15

25

125



17 Draw the graph of $y = 3x - 1$ for values of x from -1 to 3

[3 marks]

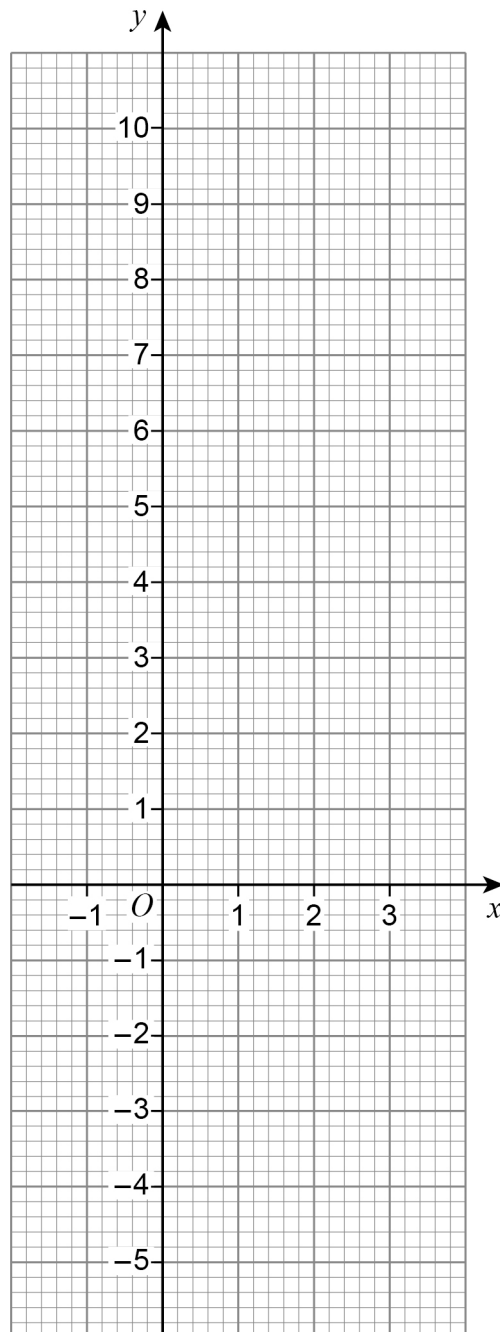

Turn over ►



18 Mo played 30 games of chess.
He won 18 of these games.

18 (a) What fraction of the games did he win?
Give your answer in its simplest form.

[2 marks]

Answer _____

18 (b) He played 20 more games.
He had then won 64% of **all** of his games.
How many of the 20 games did he win?

[3 marks]

Answer _____



19 (a) In a field
number of sheep : number of cows = 10 : 3

Zak says,

“There are 10 sheep in the field.”

Give a reason why Zak **could** be wrong.

[1 mark]

19 (b) In a different field
number of goats : number of pigs = 13 : 4

Priya says,

“There are more than three times as many goats as pigs.”

Is she correct?

Tick **one** box.

Yes

No

Cannot tell

Show working to support your answer.

[1 mark]

7

Turn over ►



20

An ordinary fair dice is rolled.

$$P(A) = \frac{5}{6}$$

Which could be a correct statement about event A?

Tick **one** box.**[1 mark]**

The number rolled is even

The number rolled is greater than 1

The number rolled is less than 5

The number rolled is prime

21

Solve $8x + 7 = 2x + 10$ **[3 marks]**

 $x =$ _____

- 22** In a **right-angled** triangle
smallest angle : largest angle = 2 : 5
Work out the three angles of the triangle. **[4 marks]**

_____ degrees

_____ degrees

_____ degrees

- 23** Which **one** of the following is discrete data?
Circle your answer. **[1 mark]**

length of arm

height of door

number of pets

mass of sugar



24 (a) Here are two triangles, P and Q.

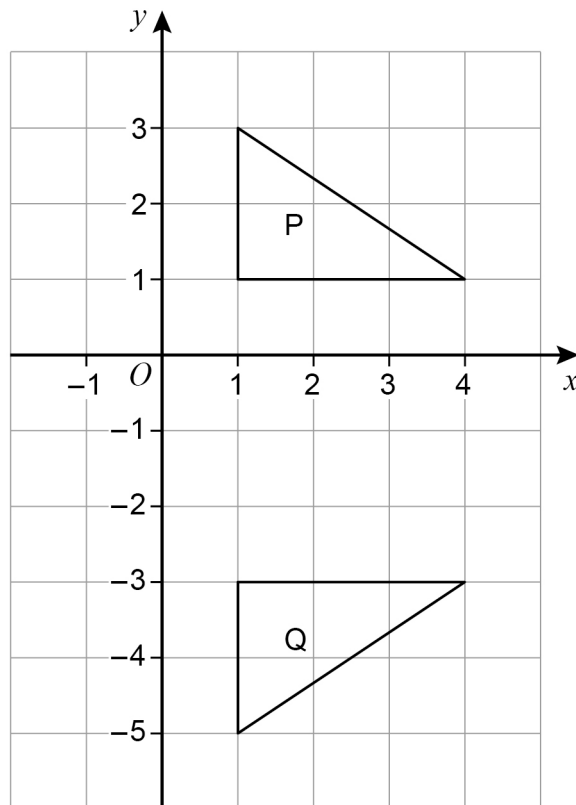

Here is a statement.

A transformation that maps P to Q is a reflection in the line $x = -1$

Make **one** criticism of the statement.

[1 mark]



24 (b) Here are two shapes, C and D.

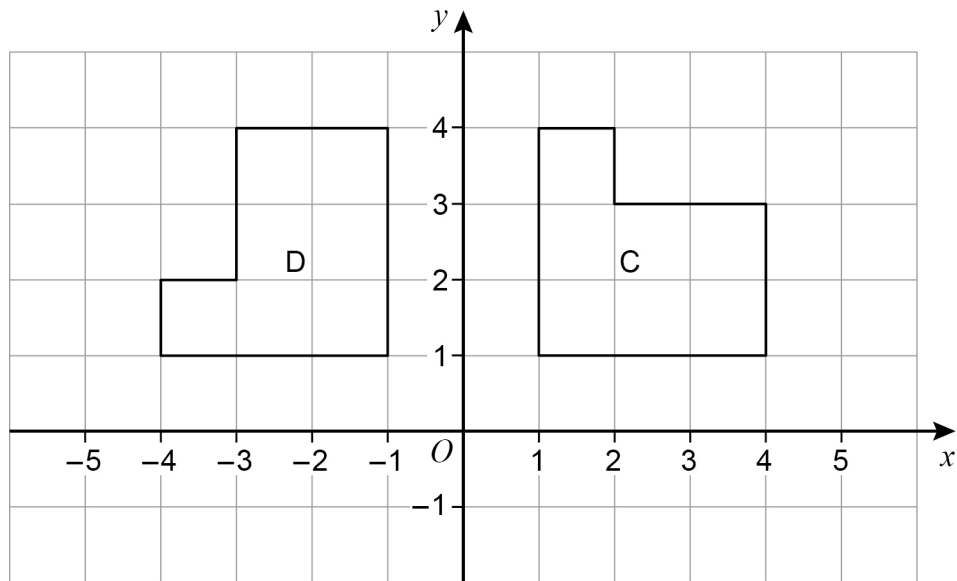

Here is a statement.

A transformation that maps C to D is a rotation through 90° anticlockwise.

Make **one** criticism of the statement.

[1 mark]

Turn over for the next question

Turn over ►



25 (a) A geometric progression starts 4 16

Work out the next term.

[1 mark]

Answer _____

25 (b) A Fibonacci-type sequence starts 3 -8

The sequence is continued by adding the previous two terms.

Work out the next **two** terms.

[2 marks]

Answer _____ and _____



26 Given that $a \times 60 = b$ work out the value of $\frac{4b}{a}$ [2 marks]

Answer _____

27 Write $27 \times (3^2)^7$ as a single power of 3 [3 marks]

Answer _____

Turn over for the next question



28

Here are two solids.

Cylinder

radius 4 cm height 10 cm

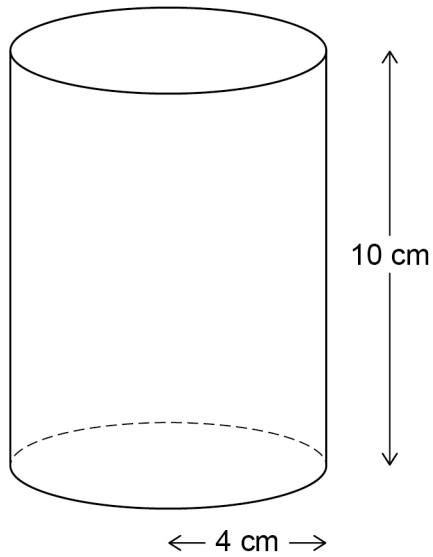
**Hemisphere**

radius 6 cm

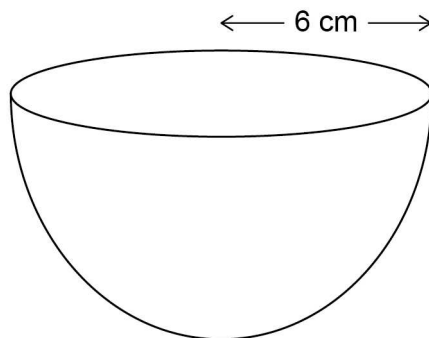

volume of a hemisphere = $\frac{2}{3} \pi r^3$ where r is the radius



Which solid has the greater volume?

You **must** show your working.

[4 marks]

Answer _____

Turn over for the next question



29

Saj makes Rose Pink paint and Cherry Pink paint.

He mixes red paint with white paint as shown.

Rose Pink
red : white = 1 : 2

Cherry Pink
red : white = 4 : 3

He makes 60 litres of Rose Pink paint.

To this Rose Pink paint he adds

80 litres of red paint and 28 litres of white paint.

Has he now made Cherry Pink paint?

You **must** show your working.

[4 marks]



30 (a) Work out $\frac{2 \times 10^{14}}{8 \times 10^9}$

Give your answer in standard form.

[2 marks]

Answer _____

30 (b) $6200.07 = 6.2 \times 10^c + 7 \times 10^d$

Work out the values of c and d .

[2 marks]

$c =$ _____ $d =$ _____

Turn over for the next question



31 $V = \frac{k}{H}$ where k is a constant.

Which **two** statements are correct?

Tick **two** boxes.

[1 mark]

V is directly proportional to H

V is inversely proportional to H

V is directly proportional to $\frac{1}{H}$

V is inversely proportional to $\frac{1}{H}$

END OF QUESTIONS



There are no questions printed on this page

*Do not write
outside the
box*

**DO NOT WRITE ON THIS PAGE
ANSWER IN THE SPACES PROVIDED**



There are no questions printed on this page

*Do not write
outside the
box*

**DO NOT WRITE ON THIS PAGE
ANSWER IN THE SPACES PROVIDED**

Copyright information

For confidentiality purposes, from the November 2015 examination series, acknowledgements of third-party copyright material are published in a separate booklet rather than including them on the examination paper or support materials. This booklet is published after each examination series and is available for free download from www.aqa.org.uk after the live examination series.

Permission to reproduce all copyright material has been applied for. In some cases, efforts to contact copyright-holders may have been unsuccessful and AQA will be happy to rectify any omissions of acknowledgements. If you have any queries please contact the Copyright Team, AQA, Stag Hill House, Guildford, GU2 7XJ.

Copyright © 2019 AQA and its licensors. All rights reserved.



2 8



1 9 B G 8 3 0 0 / 1 F

IB/M/Nov19/8300/1F